

# COMBIVERT

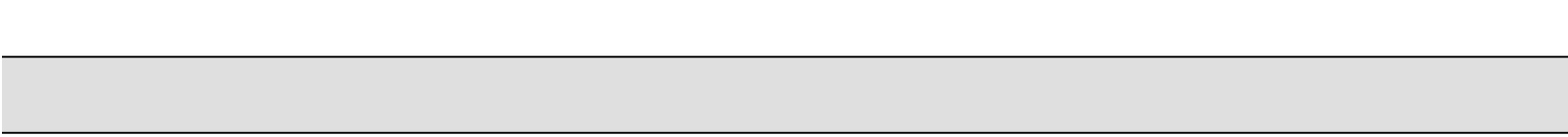

## APPLICATION MANUAL Control unit F4 - S / 1.2



<b>1</b>	<b>GENERAL</b>	<b>5</b>
<hr/>		
1.1	PRODUCT DESCRIPTION	5
1.2	SAFETY INSTRUCTIONS	5
1.3	RATING PLATE AND PART NUMBER	6
1.4	GENERAL INSTALLATION AND STORAGE INSTRUCTIONS	6
<b>2</b>	<b>CONNECTION</b>	<b>7</b>
<hr/>		
2.1	CONNECTION INSTRUCTIONS	7
2.2	RCD (FI-PROTECTIVE SWITCH)	7
2.3	INSULATION MEASURING	8
2.4	CONNECTION OF THE POWER CIRCUIT	8
2.4.1	MAINS CONNECTION	8
2.4.2	MOTOR CONNECTION	8
2.4.3	BRAKE OPTIONS	8
2.4.4	TEMPERATURE MONITORING	9
2.5	CONNECTION AND CONTROL	9
2.5.1	TERMINAL	9
2.5.2	DIGITAL INPUTS	10
2.5.3	ANALOG INPUTS	10
2.5.4	OUTPUTS	10
<b>3</b>	<b>PARAMETER STRUCTURE</b>	<b>11</b>
<hr/>		
<b>4</b>	<b>KEYBOARD OPERATION</b>	<b>13</b>
<hr/>		
4.1	STANDARD OPERATION (APPLICATION MODE)	13
4.1.1	DISPLAY OF PARAMETER IDENTIFICATION	13
4.1.2	DISPLAY OF THE PARAMETER VALUE	14
4.1.3	SPECIAL DISPLAYS	14
4.1.4	FLOW CHART AND EXAMPLE	15
4.2	THE CUSTOMER SPECIFIED PARAMETER GROUP ( CP )	16
4.3	THE DRIVE - MODE	17
4.4	PASSWORD STRUCTURE	18

<b>5</b>	<b>FUNCTIONAL DESCRIPTION</b>	<b>19</b>
5.1	RUN (RU) - PARAMETER	19
5.2	OPERATIONAL (OP) - PARAMETER	25
5.3	PROTECTION (PN) - PARAMETER	29
5.4	VOLT/HERTZ - CHARACTERISTIC (UF) - PARAMETER	39
5.5	DRIVE (DR) PARAMETER	43
5.6	CONTROL (CN) - PARAMETER	45
5.7	USER DEFINITION (UD) - PARAMETER	47
5.8	FREE-PROGRAMMABLE (FR) PARAMETER	51
5.9	ANALOG I/O (AN) - PARAMETER	55
5.10	DIGITAL INPUT (DI) - PARAMETER	59
5.11	DIGITAL OUTPUT (DO) - PARAMETER	65
5.12	LEVEL (LE) - PARAMETER	71
5.13	INFORMATION (IN) - PARAMETER	73
<b>6</b>	<b>PARAMETER TABLES</b>	<b>77</b>
6.1	RU-PARAMETER	77
6.2	OP-PARAMETER	78
6.3	PN-PARAMETER	79
6.4	UF-PARAMETER	79
6.5	DR-PARAMETER	80
6.6	CN-PARAMETER	80
6.7	UD-PARAMETER	81
6.8	FR-PARAMETER	83
6.9	AN-PARAMETER	83
6.10	DI-PARAMETER	83
6.11	DO-PARAMETER	84
6.12	LE-PARAMETER	84
6.13	IN-PARAMETER	85
<b>7</b>	<b>ANNEX FOR SOFTWARE VERSION 1.32</b>	<b>86</b>
7.1	DIFFERENCES TO THE STANDARD-SOFTWARE	86
7.1.1	MOTORPOTI FUNCTION	86
7.1.2	FAST-SCAN	88
7.1.3	POSITIONING FUNCTION	89
7.1.3.1	POSITIONING EXAMPLE	91

# 1 General

## 1.1 Product Description

In selecting the KEB COMBIVERT you have chosen a frequency inverter with the highest demands for quality and dynamic.



It exclusively serves for a stepless speed regulation of the three-phase motor.

*Application*



The operation of other electrical loads is forbidden and can lead to disturbances of the unit.

This manual describes the **control** of the standard series

*Validity Range  
of this Manual*

**COMBIVERT F4-Small**

- It includes:
- General installation and connection instructions
  - Explanation of the parameter structure
  - Operation of the keyboard surface
  - Description of all parameters
  - Parameter reference list to produce individual communication program

KEB COMBIVERT is conditionally short-circuit proof (VDE 0160). After the internal protector is reset the normal function is guaranteed.



- Exceptions:
- If an earth-leakage fault or short-circuit proof often occur, this can lead to a defect in the unit.
  - If a short-circuit occurs during regenerative operation (2nd or 4th quadrant, feedback into the intermediate circuit), then this can lead to a defect in the unit.

## 1.2 Safety Instructions

The KEB COMBIVERT is operated with voltage, which can cause an extremely dangerous shock when come into contact with. Therefore the installation of the unit and accessories is only permissible by qualified electro-personnel. A safe and trouble-free operation is only possible when the valid regulations according to DIN VDE 0100, IEC1000, EN 60204-1, EN 55014, EN 50082-2 and the relevant regulations for your area are observed.



After clearing the frequency inverter the intermediate circuit capacitors are still charged with high voltage for a short period of time. The unit can be worked on again after it has been switched off for 5 minutes.



KEB COMBIVERT is adjusted so that after a voltage breakdown or an UP-error it can restart alone. The machine manufacturer is responsible for the corresponding safety precautions.



### 1.3 Rating Plate and Part Number

Rating Plate

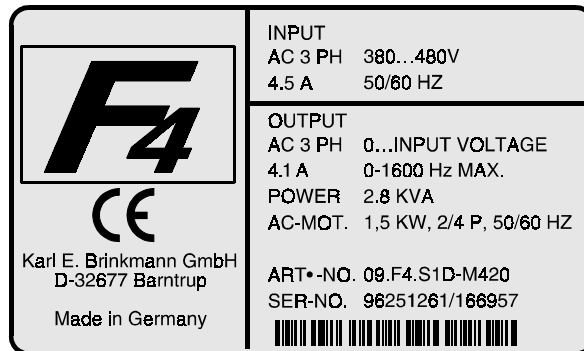

Part Number

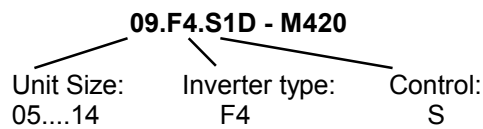

### 1.4 General Installation and Storage Instructions

Installation

Cooling Direction:

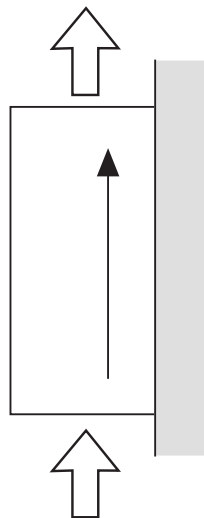

Minimum Clearance:

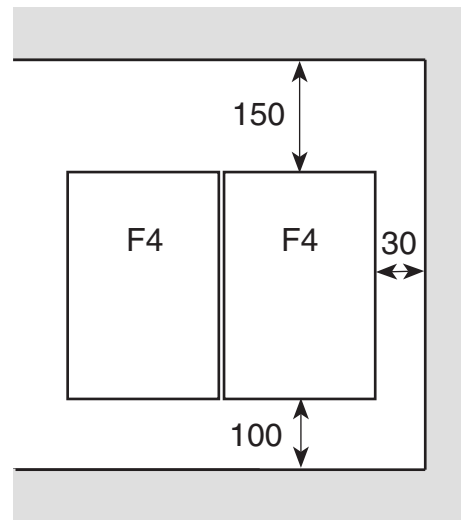

Allow room for options (e.g. braking resistance, braking module, radio interference voltage filter, choke etc.) during the planning stage of a machine.

Operating and Storage Temperature

Storage Temperature:

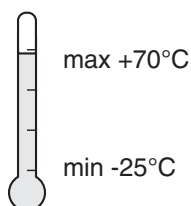

Operating Temperature:

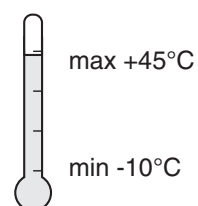

## 2 Connection

### 2.1 Connection Instructions

A trouble-free and safe operation of the frequency inverter is only guaranteed when the following connection instructions are observed. When deviated from malfunctions and damages may occur in isolated cases.

- KEB COMBIVERT is only intended for a stationary connection (discharge current > 3.5mA).
- Protective conductor cross section must be at least 10mm<sup>2</sup> copper or a 2nd conductor must be electrically parallel to the protective conductor on separate terminals (VDE 0160).
- Install electric power cable and control cable separately.
- Do not connect/disconnect the electric power cable and control cable when the frequency inverter is energized.
- Observe mains voltage and motor rated voltage.
- Use shielded/drilled control lines. Shield on PE.
- Connection of the control cables is only possible on switch and adjustment elements (relay, switch, potentiometer), which are suited for low voltages.
- Use shielded motor cables. Lay extensive shield on the motor housing.
- Connection of the braking module/braking resistor with shielded/drilled cables.
- Ground frequency inverter (asteroid; avoid earth circuits; shortest connection to main earth).



All control wires should be included in further protective measures (e.g. doubly insulated or shielded, grounded and insulated), since this deals with voltages in accordance with VDE 0160, which are not securely separated from the mains circuit, because basic insulation is used.



### 2.2 RCD (FI-Protective Switch)

If personnel protection is required during installation of the system the frequency inverters must be protected according to EN 50178 (VDE 0160):

- 1-phase inverters by RCD type A (pulse-current sensitive FI's) or type B (all-current sensitive FI's)
- 3-phase inverters (with B6 bridge-connected rectifier) by RCMA's with separation (used privileged) or RCD's type B (all-current sensitive FI's)



The tripping current should be 300mA or more, in order to avoid a premature triggering of the inverter by discharge currents (about 200mA).

Dependent on the load, the length of the motor cable and the use of a radio interference filter, substantially higher leakage current can occur.

The connection instructions from the manufacturer and the valid local requirements must be observed.

Dependent on the available mains form (TN, IT, TT) further protective measures are necessary in accordance with VDE Part 410 (Part 4; Chapter 41). For example, with TN-mains this protection is made with overcurrent protective devices. With IT-mains it is insulation monitoring with a pulse-code measuring method. A protective separation can be used with all mains forms as long as the required power and cable lengths permit this.

## 2.3 Insulation Measuring

In order to prevent damages to KEB COMBIVERT the insulation measurements may only be done in observance with important test conditions (see VDE 0558). The in- and outputs of KEB COMBIVERT must be disconnected before insulation measurements are done on the unit.

## 2.4 Connection of the Power Circuit

Dependent on the type of unit, not all power circuit terminals described here are available. A detailed description is found in the Instruction Manual for the Power Circuit.

### 2.4.1 Mains Connection

**1 - phase  
(only 230V - class)**

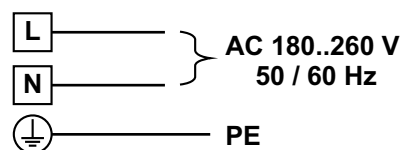

**3 - phase  
(230V and 400V class)**

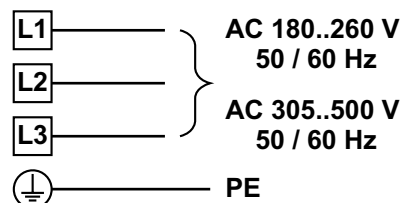

Exchanging the mains and motor connection causes immediate destruction of the unit.

### 2.4.2 Motor Connection

**Note the supply voltage and  
the correct polarization of  
the motor!**

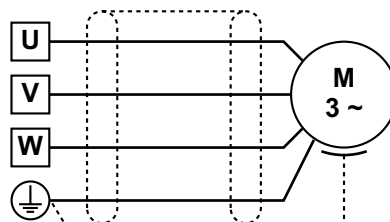

With line lengths > 15m overvoltages can occur in the motor, which can endanger the insulation system.

### 2.4.3 Brake Options

**Connection Brake Module**

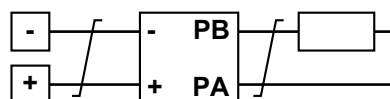

**Connection of the Braking  
Resistor  
(Internal Braking Chopper)**

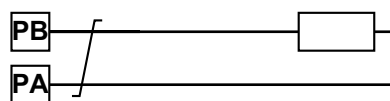

Never connected the braking resistor directly onto terminals - and +.  
The terminals + and/or PA can also be characterized with +/PA.



## 2.4.4 Temperature Monitoring

Bridge, when no monitoring occurs.

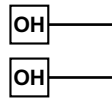

Thermocontact (NC-contact)

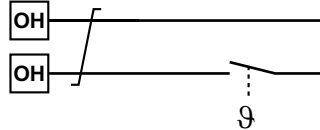

Temperature detector (PTC)

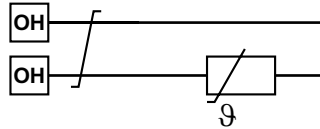

## 2.5 Connection and Control

To prevent maloperations caused by interference voltage supply observe the following:

- Use shielded / drilled lines.
- Install shield on one side of the inverter onto the earth potential.
- Install control and power cable separately (distance about 10-20cm).
- Install crossing, if not avoidable, in a right angle.



### 2.5.1 Terminal

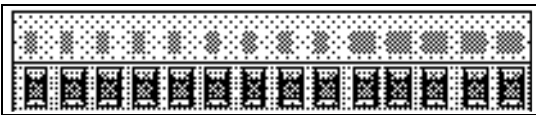

Terminal X1

Pin	Name	Function	Default Function
X1.1	RLA	programmable relay output	alarm relay
X1.2	RLB	A = NO-contact / B = NC-contact /	
X1.3	RLC	C = Basis (Out2)	
X1.4	I1	programmable digital inputs	fixed frequency 1
X1.5	I2		fixed frequency 2
X1.6	0V	ground	ground for digital I/Os
X1.7	CRF	10 V output	supply voltage for setpoint potentiometer
X1.8	REF	setpoint input	0...10VDC for analog setpoint input
X1.9	COM	common	ground for analog I/O's
X1.10	AN-OUT	analog output (digital output) (Out1)	analog output e.g.: the output frequency (An.14 = 0) or digital output (An.14 = 7)
X1.11	Uext	15 V	supply voltage for digital I/O's
X1.12	REV	direction of rotation: reverse forward	direction of rotation presetting: forward has priority
X1.13	FOR		
X1.14	ST	control release / reset	power modules released; reset when opened

## 2.5.2 Digital Inputs

Internal Voltage Supply

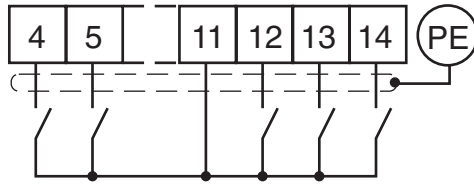

External Voltage Supply

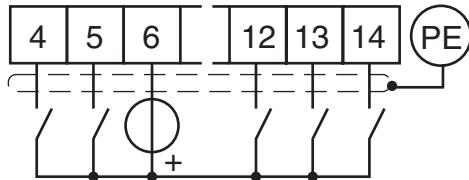

## 2.5.3 Analog Inputs

Internal Voltage Supply

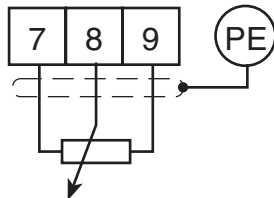

**REF**

3...10 kΩ / 0.5 W

External Voltage Supply

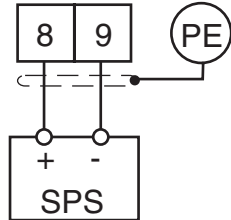

**REF**

0...10V Ri ≈ 56 kΩ



Analog inputs that are not used must be connected to the earth reference. To prevent undefined conditions during external supply, make sure to switch on the supply first and then the inverter.

## 2.5.4 Outputs

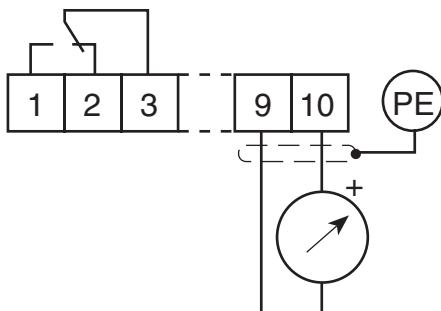

**Analog Output:**

0...10V DC when  $R_i \geq 56 \text{ k}\Omega$  const.

0...1mA DC when  $R_i \leq 5 \text{ k}\Omega$  const.

0 or 10V as digital output (An.14 = 7).

Relay RLA/B/C

## 3 Parameter Structure

Each parameter is divided into 3 groups:

1. Parameter number
2. Parameter group
3. Parameter set (only with programmable parameters)

The parameter numbers distinguish between each parameter in a group. Parameter groups are combined according to their functions. This means all parameters needed to set a function are found in a parameter group. Combivert F4-S has the following parameter groups.

*Parameter Groups  
and Parameter  
Numbers*

<b>Run(ru) - Parameter</b>	Contains all operating displays, i.e. all values that change during operation, without changing the parameter.
<b>Operational(oP) - Parameter</b>	All parameters for the setpoint input, limitation, ramp presetting etc.
<b>Protection(Pn) - Parameter</b>	All protective functions (e.g. LA-Stop) and all Keep-on-run functions (e.g. Auto Restart).
<b>(uF) - Parameter</b>	Setting of volt/hertz-characteristic as well as the modulation parameter (e.g. switching frequency).
<b>Drive(dr) - Parameter</b>	All motor specific parameters.
<b>Control(cn) - Parameter</b>	Control parameters for speed and torque
<b>User-definition(ud) - Parameter</b>	All parameters for individual setting of the operating surface and the serial interface.
<b>Free-prog.(Fr) - Parameter</b>	Programs and activates parameter sets.
<b>Analog-I/O(An) - Parameter</b>	Programs the analog in-/outputs
<b>Digital-In(di) - Parameter</b>	Programs the digital inputs.
<b>Digital-Out(do) - Parameter</b>	Programs the digital outputs.
<b>Level(LE) - Parameter</b>	Switching conditions for the digital outputs.
<b>Information(In) - Parameter</b>	Information about inverter type, serial no. and diagnostic parameter like error counter, Quality Assurance number.

# Parameter Structure

## Functions of the Parameter Groups

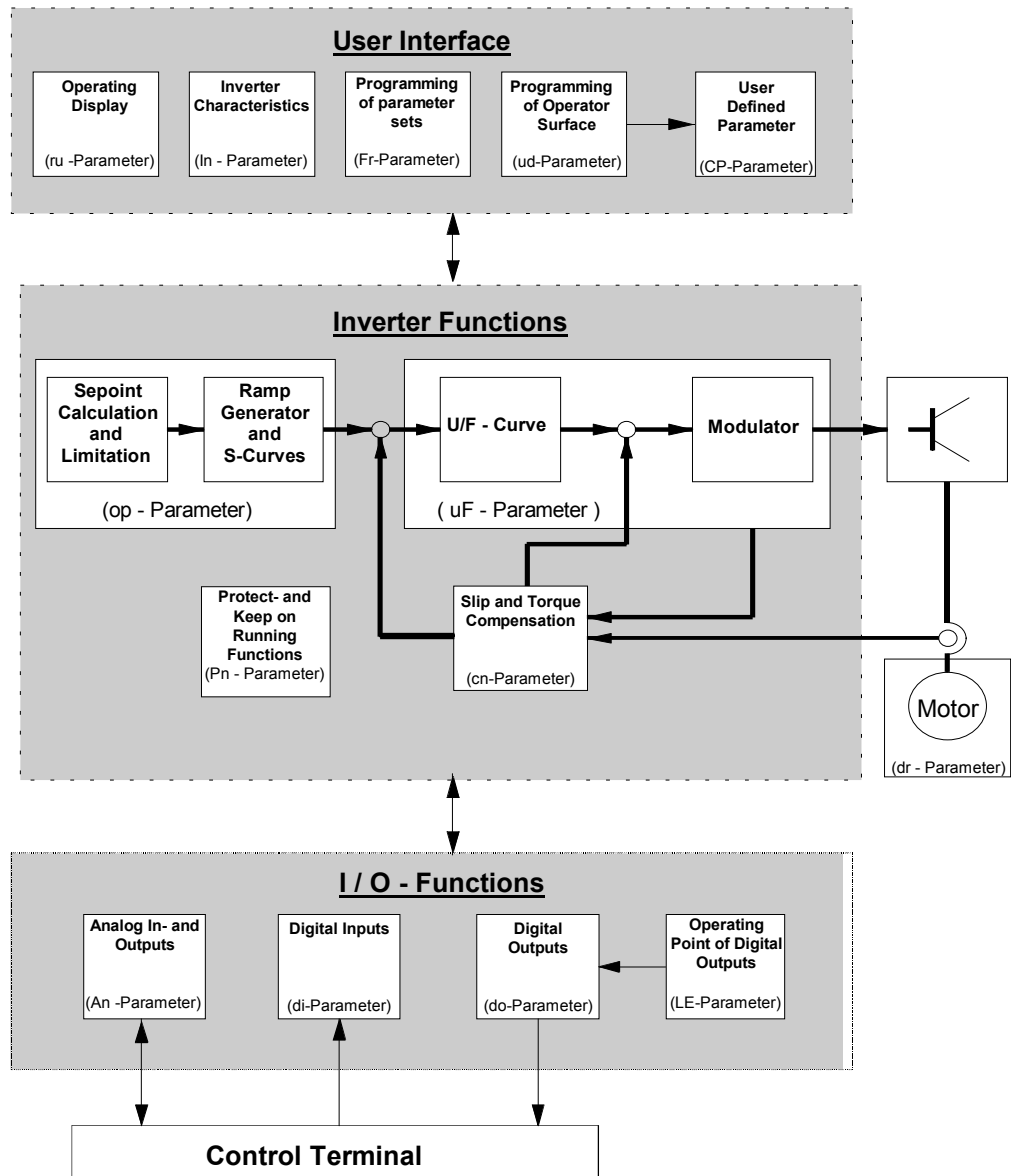

## Parameter Sets

There are 4 programmable parameters (parameter sets 0-3) and for each programmable parameter up to 4 different values can be stored. The values of the actual set selected are always active. Sets can be switched between during operation. This switching is done via terminal strip, keyboard or bus interface.

Example: REF SOURCE (op.0) is programmed in all sets with 2 (frequency reference setting +/- Digital-Abs).

REF SETTING ABS (oP.1) has the following value in sets 0 - 3:

Set 0:	0 Hz
Set 1:	10 Hz
Set 2:	20 Hz
Set 3:	30 Hz

Depending on the set chosen the set value is 10, 20 or 30 Hz.

For all non-programmable parameters the same value is valid regardless of the set selected.

## 4 Keyboard Operation

### 4.1 Standard Operation (Application Mode)

There are two fundamental operating modes for keyboard operation.

1. Displays and changes the parameter identification (Number, group and set)
2. Displays and changes the parameter values.

To change between these modes press the FUNCT key. When the FUNCT key is pressed in mode 1, the value of the parameter set is displayed. When pressed again the parameter identification is displayed.

#### 4.1.1 Display of Parameter Identification

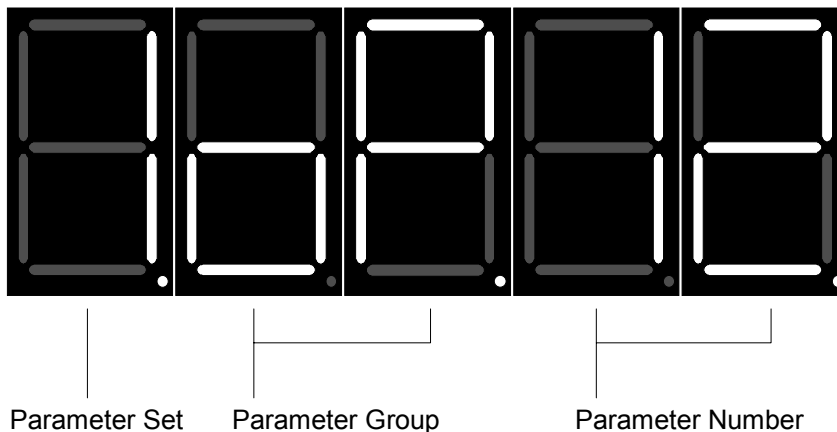

*Display Parameter Identification*

The individual specifications for identification of the parameters are separated by dots. One of these dots blinks and displays the specifications which can be changed by UP/DOWN. The blinking dot can be shifted to the left by pressing ENTER. If ENTER is pressed when the point is blinking, then the dot of the parameter number will blink next. No set number is shown for non-programmable parameters. By pressing ENTER you can only switch between parameter number and parameter group.

To select another parameter group press ENTER until the dot behind the parameter group display blinks. The desired parameter group can now be set with UP/DOWN. When the parameter group is changed, then the parameter number is set onto the lowest parameter number available in the new group (generally 0). The adjusted set is not changed. If the new parameter is not programmable then no parameter set is visible.

*Changing the Parameter Group*

To change the parameter number, the blinking dot must be brought behind the display of the parameter number. Thereafter the parameter number can be changed with UP/DOWN. If the largest parameter of a group is reached and UP is pressed, then the lowest parameter number of this group appears. If the lowest parameter number is reached and DOWN is pressed, then the largest parameter number of this group appears. Changing the parameter number does not change the parameter group nor the parameter set. No set number is displayed for non-programmable parameters.

*Changing the Parameter Number*

## *Changing the Parameter Set*

The parameter set can only be changed by a programmable parameter. After the blinking dot is brought behind the display of the parameter set with ENTER, then the desired set can be adjusted with UP/DOWN. This is not necessarily the set in which the inverter presently operates, but rather the set of the parameter selected which should be displayed or changed.

In addition to sets 0-3 the value A (active) can also be set. During this setting the value is always shown which is being adjusted in the set presently active. The adjusted parameter value cannot be changed in this setting.

## **4.1.2 Display of the Parameter Value**

### *Changing the Parameter Values*

By pressing UP or DOWN the value of the adjusted parameter can be changed in the parameter value display. These changes are effective immediately and permanently stored, meaning they are still valid after the unit is switched off. ENTER does not need to be pressed to confirm the input.

### *Enter Parameter*

For some parameters it is not useful, that the value set by UP/DOWN immediately be valid. When for example, during digital rotation setting you want to change from LS to REV, then FOR may not immediately be activated when UP is pressed. These parameters are called Enter parameters, because they must be verified by ENTER. Only the display is changed when pressing UP /DOWN and not the value stored in the inverter. When the display value and the stored value in the inverter are different, this is characterized by a point in the display. The display value in the inverter is stored and the dot is no longer visible when ENTER is pressed. The parameter value display of an Enter parameter always begins with the value stored in the inverter. A list of all Enter parameters is found in the supplement.

## **4.1.3 Special Displays**

### *Display of an Error Message*

When a malfunction occurs in the inverter the display is overwritten by an error message. This error message blinks. By pressing ENTER the display of the error message is interrupted and the parameter value of the last parameter adjusted is shown. No error reset occurs when ENTER is pressed, meaning the error status in the inverter is not reset. As a result it is possible to correct adjustments before an error reset. An error reset is only possible with the terminal control release or reset.

### *Display of Feedback*

Some inputs, e.g. copying a set, are acknowledged with a message from the inverter. Possible displays:

PASS	Set was copied
nco	Set could not be copied

## 4.1.4 Flow Chart and Example

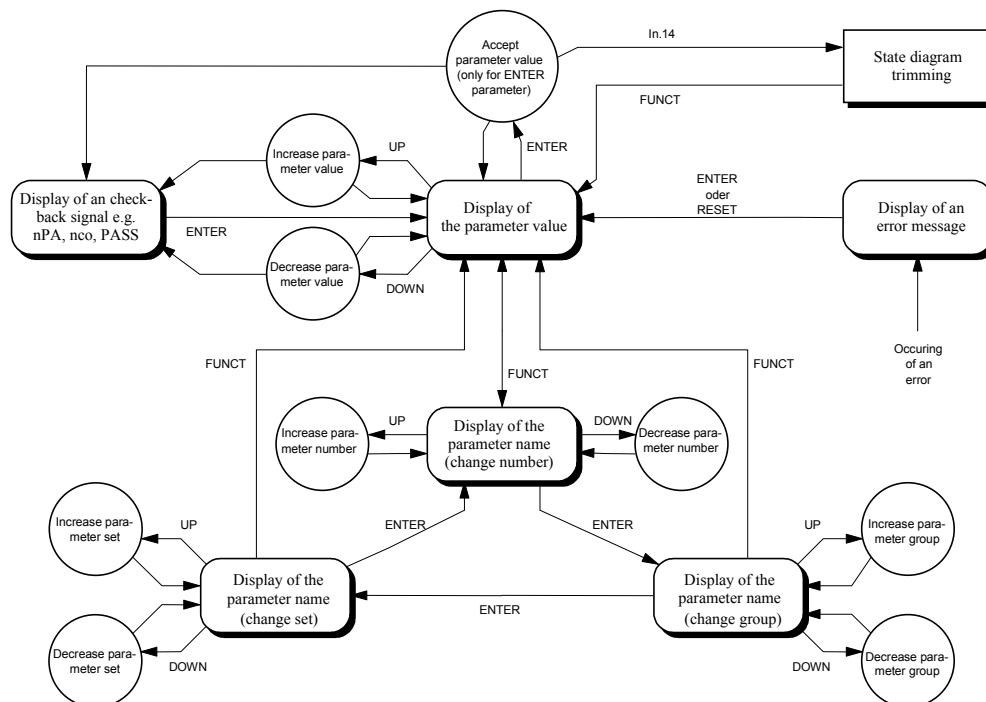

Flow Chart Keyboard Operation

To go from 0.Pn. 4 to 3.uF. 8, the following steps are necessary:

Example

1. press ENTER => The blinking dot changes from the parameter number to parameter group
2. press UP / DOWN until uF is shown as a parameter group
3. press ENTER => The blinking dot changes from parameter group to parameter set
4. press UP / DOWN until parameter set 3 is displayed
5. press ENTER => The blinking point changes from parameter set to parameter number
6. press UP / DOWN until parameter number 8 is displayed

## 4.2 The Customer Specified Parameter Group ( cP )

### Customer Parameter Group

The cP parameter group is defined in the ud-group (USER DEFINITION) and **can't** be changed.

UP/DOWN is used to change between these parameters. A change of the group or set is not possible. FUNCT is used to switch between the parameter value display and parameter identification.

### Change between cP- and application mode

To change from the standard parameter group to the customer group and vice versa the corresponding passwords must be entered (see chapter 5.7 / parameter ud. 0).

### Parameters of the CP-group

Display	Application Parameter	Parameter	Adjust. range	Resolution	Factory setting
CP. 0	ud.0	Password input	0...9999	1	–
CP. 1	ru.3	Actual speed display	–	0.0125 Hz	–
CP. 2	ru.0	Inverter status	–	1	–
CP. 3	ru.7	Apparent current	–	1 %	–
CP. 4	ru.8	Peak apparent current	–	1 %	–
CP. 5	uF.0	Actual torque	0..409.58 Hz	0.0125 Hz	50.0 Hz
CP. 6	uF.1	Boost	0...25.5 %	0.1 %	2.0 %
CP. 7	oP.11	Acceleration time	0.01...300 s	0.01 s	10 s
CP. 8	oP.12	Deceleration time	0.01...300 s	0.01 s	10 s
CP. 9	oP.4	Minimum Reference	0...409.58 Hz	0.0125 Hz	0 Hz
CP. 10	oP.5	Maximum Reference	0...409.58 Hz	0.0125 Hz	70 Hz
CP. 11	oP.22	Step Frequency 1	±409.58 Hz	0.0125 Hz	5 Hz
CP. 12	oP.23	Step Frequency 2	±409.58 Hz	0.0125 Hz	50 Hz
CP. 13	oP.24	Step Frequency 3	±409.58 Hz	0.0125 Hz	70 Hz
CP. 14	Pn.5	LAD load level	10...200 %	1 %	140 %
CP. 15	Pn.13	Stall level	10...200 %, off	1 %	off
CP. 16	Pn.7	Speed search condition	off, 1..15	1	8
CP. 17	uF.8	DC-voltage compensation	150...649 V, off	1 V	off
CP. 18	cn.1	Slip compensation	-2.50...2.50	0.01	0 = off
CP. 19	cn.2	Autoboost	-2.50...2.50	0.01	0 = off
CP. 20	Pn.8	DC-braking	0...9	1	7
CP. 21	Pn.11	DC-braking time	0...100	0.01 s	10 s
CP. 22	do.2	Relay output	0...24	1	2
CP. 23	Le.1	Frequency level	0...409,58 Hz	0.0125 Hz	4 Hz



## 4.3 The Drive - Mode

The Drive-Mode is used to start the drive manually. In this mode it is only possible to preset the direction of rotation and the digital frequency reference.

In addition to their normal function the keys have a special assignment:

ENTER key	=>	Additional function F/R (change of the direction of rotation)
FUNCT key	=>	Additional function SPEED (Presets the set frequency)
UP key	=>	Additional function START
DOWN key	=>	Additional function STOP

The set direction of rotation can be changed by F/R.

If the SPEED key is pressed, then the set frequency is shown. By **simultaneously** pressing the UP or DOWN key the set frequency can be changed.

*Drive - Mode Flow Chart*

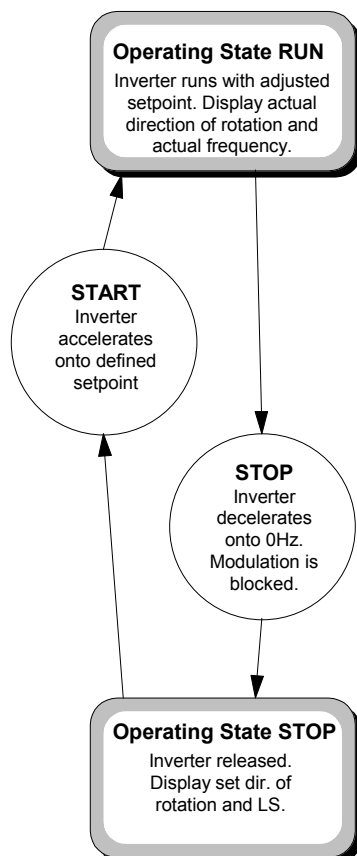

## Display in Drive - Mode

The display in Drive-Mode is divided differently than in the Customer- and Application-Mode.

Working Condition	1st Digit	2nd - 5th Digit
STOP	set direction of rotation (F / r)	LS (noP, when ST is not active)
START	actual dir. of rot. (F / r)	actual frequency
RUN	actual dir. of rot. (F / r)	actual frequency
SPEED-display	reserved	actual frequency

## Entering / Leaving the Drive - Mode

The Drive-mode is called up when the Driver password is entered in parameter cP.0 and/or ud.0. The initial state is STOP.

It is only possible to leave the Drive-Mode with STOP and/or START. If the keys ENTER and FUNCT are simultaneously pressed for about 3s, then the the operating surface changes to the display of the password (cP. 0 and/or ud. 0). The the password level becomes active that was active before the Drive-Mode was called up.

## 4.4 Password Structure

### Password Input

The password is entered with parameter ud. 0 (Application-Mode) and/or cP. 0 (Customer-Mode).

In this case the password remains stored after Power On and must not be released again each time the unit is switched on. There are 5 password levels of which 1 is always active. When a new password is entered the password level changes. Inputs that do not match a valid password are ignored.

The supervisor password is not stored when the unit is switched off. Once the unit is switched on again the password that was valid before the service password is active.

### Password List

- |                   |  |
|-------------------|--|
| 1. CP - READ ONLY | Only the Customer parameter group is visible. Only CP. 0 (Password in) can be changed.   |
| 2. CP - ON        | Only the Customer parameter group is visible. All Customer parameters can be changed.  |
| 3. CP - SERVICE   | Corresponds to the Customer password. The parameter identification of the parameter is shown that is assigned to the Customer parameter. |
| 4. APPLICATION    | All Application parameters are visible and can be changed. The Customer group is not visible.  |
| 5. SUPERVISOR     | All parameters are visible and can be changed. The Customer group is not visible.  |
| 6. DRIVE - MODE   | The unit is controlled by the keyboard.  |

## 5 Functional Description

### 5.1 run (ru) - Parameter

In the run(ru) parameter group all parameters are combined in which the actual operating condition of the inverter can be read. The parameters of this group are read-only. Exception: parameters ru. 8 and ru.12 are set to 0 by entering any value.

*General*

*Parameter  
Summary*

ru. 0	INVERTER STATE
ru. 3	ACTUAL FREQUENCY DISPLAY
ru. 6	SET FREQUENCY DISPLAY
ru. 7	ACTUAL INVERTER UTILIZATION
ru. 8	PEAK INVERTER UTILIZATION
ru. 9	APPARENT CURRENT
ru. 10	ACTIVE CURRENT
ru. 11	ACTUAL DC VOLTAGE
ru. 12	PEAK DC VOLTAGE
ru. 13	OUTPUT VOLTAGE
ru. 14	INPUT TERMINAL STATE
ru. 15	OUTPUT TERMINAL STATE
ru. 16	INTERNAL INPUT STATE
ru. 17	INTERNAL OUTPUT STATE
ru. 18	ACTUAL PARAMETER SET
ru. 23	REF 2 DISPLAY
ru. 24	OL COUNTER DISPLAY
ru. 29	HEAT SINK TEMPERATURE

*Inverter State (ru.0)* In (ru. 0) the working condition of the inverter is shown. The various displays are explained below.

Display	Value	Significance
noP	0	No Operation: control release not activated, modulation switched off, output voltage = 0, drive not guided
E.OP	1	Over Potential, dc-bus voltage too high
E.UP	2	Under Potential, dc-bus voltage too low
E.OC	4	Over Current, output current > 2 * I <sub>rated</sub> (constant torque)
E.OH	8	Over Heat, overheating of the inverter
E.dOH	9	Drive Over Heat, temperature monitoring of the motor was triggered and the delay time has run out
E.LSF	15	Ladeshunt Fault, ladeshunt not connected
E.OL	16	Over Load, overload monitoring of the inverter was triggered
E.nOL	17	No Over Load, cooling period E.OL has run out, error can be reset
E.EF	31	External Fault, error message through external unit  A hardware error occurs if E.EF is not programmed (s. page 61). Measure: Send unit to the repair service
E.nOH	36	No Over Heat, overtemperature error is no longer present (E.OH or E.dOH), error can be reset
E.SET	39	Set selection error
E.PuC	49	Power circuit identity invalid
FAcc	64	Forward Acceleration: drive accelerated forward
FdEC	65	Forward Deceleration: drive decelerates forward
Fcon	66	Forward Constant: drive runs with constant speed forward
rACC	67	Reverse Acceleration: drive accelerates in reverse
rdEC	68	Reverse Deceleration: drive decelerates in reverse

Display	Value	Significance
rcon	69	Reverse Constant: drive runs with constant speed in reverse
LS	70	Low Speed: Control release is activated, no direction of rotation is preset, modulation is switched off, output voltage = 0, drive is not guided
SLL	71	Stall function is active
LAS	72	LA - Stop is active (acceleration ramp stopped)
LdS	73	LD - Stop is active (deceleration ramp stopped)
SSF	74	Speed - Search - function is active
dcb	75	DC - braking is active
bbl	76	Base - Block time runs out, d.c. to a.c. switched off
dLS	77	Low Speed according to DC - braking

In ru. 3 the actual output frequency of the inverter with a resolution of 0.1 Hz is shown. A reverse rotating field at the output (Reverse) is represented by a display of negative frequencies.

*Actual Frequency  
Display (ru. 3)*

Examples: Display: 18.1   => Output frequency 18.1 Hz, forward  
 Display: -18.1   => Output frequency 18.1 Hz, reverse

Attention: The display of ru.3 and ru.6 have a resolution of 0,0125 Hz via bus.

ru. 6 shows the actual set frequency. The resolution and the display of different directions of rotation correspond to ru. 3. If no direction of rotation is selected, then the set value is displayed which would result from a forward direction of rotation. It is possible to check the given set value before the direction of rotation is enabled.

*Set Frequency  
Display (ru. 6)*

Parameter ru. 7 specifies the actual utilization of the inverter in %. 100% means the output current is equal to the rated current of the inverter. Only positive values are displayed, i.e. you cannot determine whether the drive is motor-driven or in regenerative operation.

*Actual Inverter  
Utilization (ru. 7)*

## ru - Parameter

### *Peak Inverter Utilization (ru. 8)*

ru. 8 makes it possible to detect the peak utilization within an operating cycle. In addition the highest value that occurs in ru. 7 is stored in ru. 8. The peak memory can be deleted by pressing the UP or DOWN key or by bus in writing any value onto ru. 8. When the inverter is switched off the memory is deleted.

### *Apparent Current (ru. 9)*

Display of the actual apparent current (resolution of 0.1A). The resolution by bus amounts to 0.1A.

### *Active Current (ru.10)*

ru.10 shows the actual active current excluding the part of the active current needed for the stator losses. The display of ru.10 is approximately proportional to the given torque. To maintain the correct display of the torque building active current it is important to enter the motor parameter (dr.1... dr.5) corresponding to the rating plate.

### *Actual DC Voltage (ru.11, ru.12)*

Display of the actual dc-voltage (resolution of 1V). The highest value (drag pointer) that occurs is stored in ru.12. ru.12 is erased by pressing UP or DOWN. The peak hold can be deleted with bus by writing any value in ru.12. ru.12 is also erased by power on reset of the inverter.

### *Output Voltage (ru.13)*

Display of the present output voltage (resolution of 1V).

### *Input Terminal State (ru.14)*

ru.14 shows the logical condition of the input terminal. Logical interconnections, strobe or edge triggering are not taken into consideration.

Bit -No.	Decimal Value	Input	Terminal
0	1	ST (Control Release)	14
1	2	RST (Reset)	14
2	4	F (Forward)	13
3	8	R (Reverse)	12
4	16	I1 (Programmed input 1)	4
5	32	I2 (Programmed input 2)	5

If an input is triggered, then the corresponding decimal value is displayed. If several inputs are triggered, then the sum of the decimal values are displayed.

### *Output Terminal State (ru.15)*

ru.15 makes it possible to control the digital outputs. It takes into consideration the logical interconnection of the digital outputs (do. 0, do. 9 to do.25). For every active output the corresponding decimal value is shown. If several outputs are active then the sum of the decimal values are displayed.

Bit -No.	Decimal Value	Output	Terminal
0	1	Out 1 (analog output)	10
1	2	Out 2 (Relay RLA,RLB,RLC)	1 , 2 , 3

Shows the binary coded status of the terminal input signals after the strobe, triggering and logical interconnection through the di-Parameter

*Internal Input State (ru.16)*

Bit -No.	Decimal Value	Input	Terminals
0	1	ST (Control Release)	14
1	2	RST (Reset)	14
2	4	F (Forward)	13
3	8	R (Reverse)	12
4	16	I1 (Programmed. Input 1)	4
5	32	I2 (Programmed. Input 2)	5

If an input is triggered, then the corresponding decimal value is displayed. If several inputs are triggered, then the sum of the decimal values is displayed.

ru.17 displays the results of the output function table (do. 1 to do. 2). If the output condition is met, then the corresponding decimal value is displayed. If several output conditions are met, then the sum of the decimal values are displayed.

*Internal Output State (ru.17)*

Bit - No.	Decimal value	Output Condition
0	1	Out1 Condition (do. 1)
1	2	Out2 Condition (do. 2)

Displays the parameter set currently active.

This means: - the number of the parameter set in which the inverter operates is shown  
 - the number of the parameter set in which the parameter values are changed by bus is not shown

*Actual Parameter Set (ru.18)*

Checks the analog channel Ref.

Shows the current value of the Ref, while 100% = 10V.

*Ref2 Display (ru.23)*

The continuous load of the inverter is analyzed by this parameter in order to prevent OL (punctual load reduction) from occurring. Error OL is triggered when the OL-counter reaches 100 % . The count is shown with a 1 % resolution.

*OL - Counter Display (ru.24)*

ru.29 shows the actual heat sink temperature in °C. Resolution = 1 °C.

*Heat Sink Temperature (ru.29)*





## 5.2 Operational (oP) - Parameter

oP. 0	FREQUENCY REFERENCE SOURCE
oP. 1	FREQUENCY REFERENCE SETTING ABSOLUTE
oP. 2	FREQUENCY REFERENCE SETTING
oP. 3	ROTATION SETTING
oP. 4	MINIMUM REFERENCE
oP. 5	MAXIMUM REFERENCE
oP. 8	ABS. MAXIMUM FREQUENCY
oP. 11	ACCELERATION TIME
oP. 12	DECELERATION TIME
oP. 22	STEP FREQUENCY 1
oP. 23	STEP FREQUENCY 2
oP. 24	STEP FREQUENCY 3
oP. 25	STEP FREQUENCY MODE

*Parameter Summary*

## oP - Parameter

### Frequency Reference Source (oP. 0)

Generally oP.0 consists of 2 components: the amount of the setpoint and the direction of rotation. The table below shows the various frequency reference settings.

oP. 0	Setpoint	Direction of Rotation
0	analog	digital (oP. 3)
1	analog	Terminal
2	analog	always forward
3	digital-absolute (oP. 1)	digital (oP. 3)
4	digital-absolute (oP. 1)	terminal
5	digital-absolute (oP. 1)	sign digital-absolute (oP. 1)
6	digital-% (oP. 2)	digital (oP. 3)
7	digital-% (oP. 2)	terminal
8	digital-% (oP. 2)	sign digital-% (oP. 2)

### Analog Frequency Reference Setting:

The frequency setpoint ( $F_{set}$ ) is calculated as follows:

$$F_{set} = \frac{F_{max} - F_{min}}{100\%} * \text{analog value} + F_{min}$$

The setpoint is preset via REF. A value between -100% and +100% is supplied through the analog channel.

### Frequency Reference Setting Absolute (op. 1)

The desired frequency value is directly set by the digital frequency reference setting as the absolute value (oP. 0 = 3-5) by parameter oP. 1. As with the analog frequency reference setting negative values of oP.1 are set at = 0, when the set direction of rotation is preset with oP. 3 or by terminal strip. If the direction of rotation is indicated in oP. 1, then negative frequencies mean reverse and positive frequencies forward. The value of oP. 1 is not limited by the input, meaning all values between - range end and +range end are preset. All values are accepted by the inverter, and confirmed by Bus with a positive acknowledgement. Internally the set value is limited and also the display in ru. 6 shows the limited reference source.

### Frequency Reference Setting (op. 2)

The proportional digital frequency reference setting (oP. 0 = 6-8) via oP. 2 is equal to the analog frequency reference setting, whereby the setpoint is preset by oP.2 in the range from -100% to +100%.

### Rotation Setting (oP. 3)

Defines the set direction of rotation which determines the set frequency. oP. 0 must be programmed onto digital direction of rotation setting (0, 3 or 6) for this.

oP. 3	Set Direction of Rotation
0	Low Speed (LS)
1	Forward (F)
2	Reverse (r)

The minimum- and maximum frequencies limit the setpoints, which are transferred to the ramp generator to generate the output frequencies. They also help determine the curve during analog frequency reference setting. An analog value of +100% corresponds to the adjusted setpoint in oP. 5.

*Minimum- and Maximum Frequencies (oP.4, oP.5)*

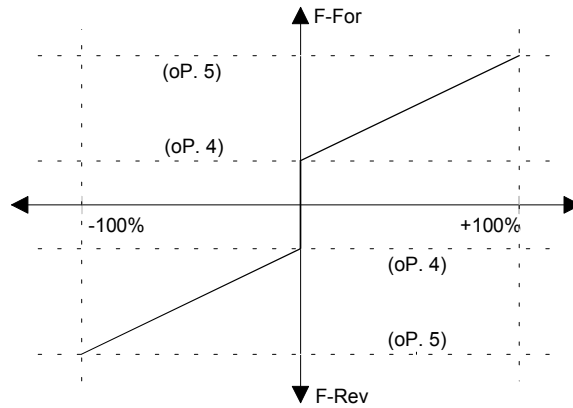

The absolute maximum frequency (oP. 8) limits the output frequency of the inverter, e.g. no output of frequencies > oP. 8.

*Absolute Maximum Frequencies (oP. 8)*

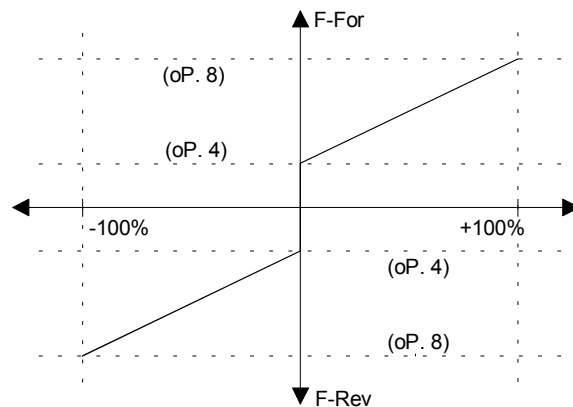

# oP - Parameter

## Acceleration and Deceleration Times (oP.11 - oP.14)

The acceleration and deceleration times are preset. The times refer to a frequency difference of 100 Hz.

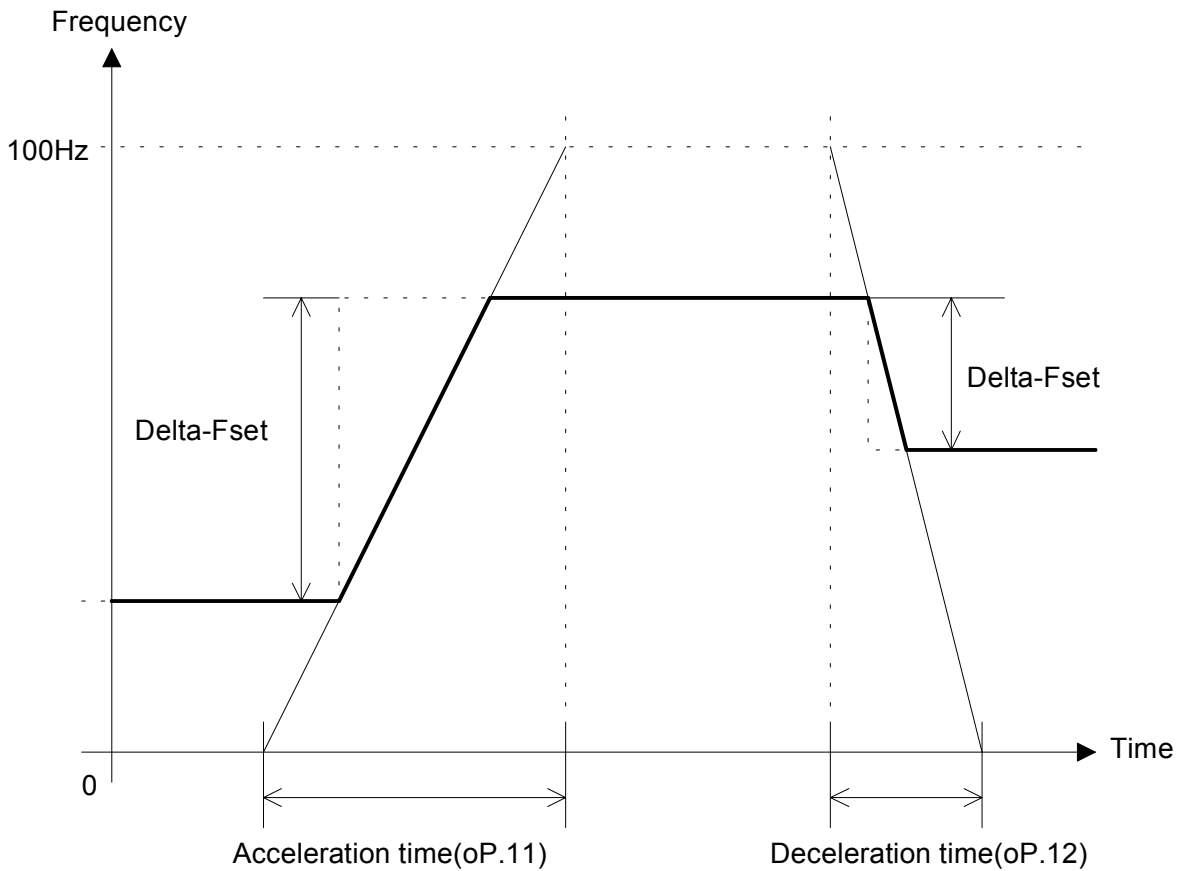

## Step Frequencies (op.22 - op.24)

When I1 or I2 is programmed onto the step speed setting, then up to 3 step frequencies per parameter set can be activated by I1 and I2. The set values of these step frequencies are programmed in parameters oP.22 - 24. If a programmed input is activated on a step frequency setting, then irrespective from the programmed frequency reference source (oP.0) the corresponding step frequency value is used as a set value.

I1	I2	Significance
0	0	Standard set value
0	1	Step frequency 1
1	0	Step frequency 2
1	1	Step frequency 3

## Step Frequency Mode (oP.25)

oP.25 programs the release of the step frequency and the source for the set direction of rotation.

Value	Significance
0	Step frequency deactivated
1	Set direction of rotation with oP. 3
2	Set direction of rotation with terminal strip
3	Set direction of rotation with step frequency value

### 5.3 Protection (Pn) - Parameter

Pn. 0	AUTOMATIC RETRY UP
Pn. 1	AUTOMATIC RETRY OP
Pn. 2	AUTOMATIC RETRY OC
Pn. 4	LAD STOP FUNCTION
Pn. 5	LAD LOAD LEVEL
Pn. 6	LD VOLTAGE
Pn. 7	SPEED SEARCH CONDITION
Pn. 8	DC BRAKING MODE
Pn. 9	DC BRAKE START FREQUENCY
Pn. 10	DC BRAKE MAXIMUM VOLTAGE
Pn. 11	DC BRAKING TIME
Pn. 12	STALL MODE
Pn. 13	STALL LEVEL
Pn. 14	STALL ACC/DEC TIME
Pn. 16	E.dOH DELAY TIME

*Parameter Summary*

## Pn - Parameter

### Hardware Current Limit

The hardware current limit has a higher priority than the Pn-Parameter and could not be deactivated. The response of the hardware current limit initiates no error, that can lead to torque dips at the motor shaft. This is of particular importance for the operation „Hoisting and lowering“, since the drive can sack due to missing torque without engagement of the brake.

### Automatic Retry UP (Pn. 0) OP (Pn. 1) OC (Pn. 2)

When a function is activated the prevailing error is automatically reset.

Value	Significance
0	Function switched off
1	Function switched on

### LAD Stop Function (Pn. 4)

The acceleration-/deceleration ramps can be stopped, dependent on the rate of utilization and/or the intermediate circuit voltage. The following stopping conditions are possible

Bit - No.	Decimal Value	Stop Conditions
0	1	Acceleration ramps are interrupted, as long as the rate of utilization is > Pn. 5
1	2	Deceleration ramps are interrupted, as long as the intermediate circuit voltage is > Pn. 6
2	4	Deceleration ramps are interrupted, as long as the rate of utilization is > Pn. 5

In case several stop conditions should be activated, then the sum of the decimal values must be adjusted.

### LAD Load Level (Pn. 5)

In Pn.5 the comparison value for the LAD stop conditions (Bit 0 and Bit 2) are set. Pn.5 is compared with the actual rate of utilization. In case this is larger than Pn. 5 and the corresponding stop conditions are activated, then the ramp is stopped. Pn. 5 is given as the percent value, in relation to the inverter rated current.

### LD Voltage (Pn. 6)

Pn. 6 specifies the comparison value for LAD stop conditions (Bit 1). The intermediate circuit voltage is given with a resolution of 1V. When the intermediate circuit voltage exceeds the setpoint and the corresponding stop condition is activated, then the ramp is stopped.

Pn.7 allows the inverter to switch onto a motor slowing down. After the function is activated, it searches the actual motor speed and fits the output frequency accordingly. If the synchronization point is found, then the inverter accelerates the drive with the adjusted ACC ramp onto the setpoint. The conditions, when the functions should become active, can be selected by parameter Pn. 7.

*Speed Search Condition (Pn. 7)*

Bit - No.	Decimal Value	Speed Search by
0	1	Control release
1	2	Power on reset
2	4	Reset
3	8	Automat. restart

In case several conditions should be activated, then the sum of the decimal values must be adjusted.

*Speed Search Condition Flow Chart*

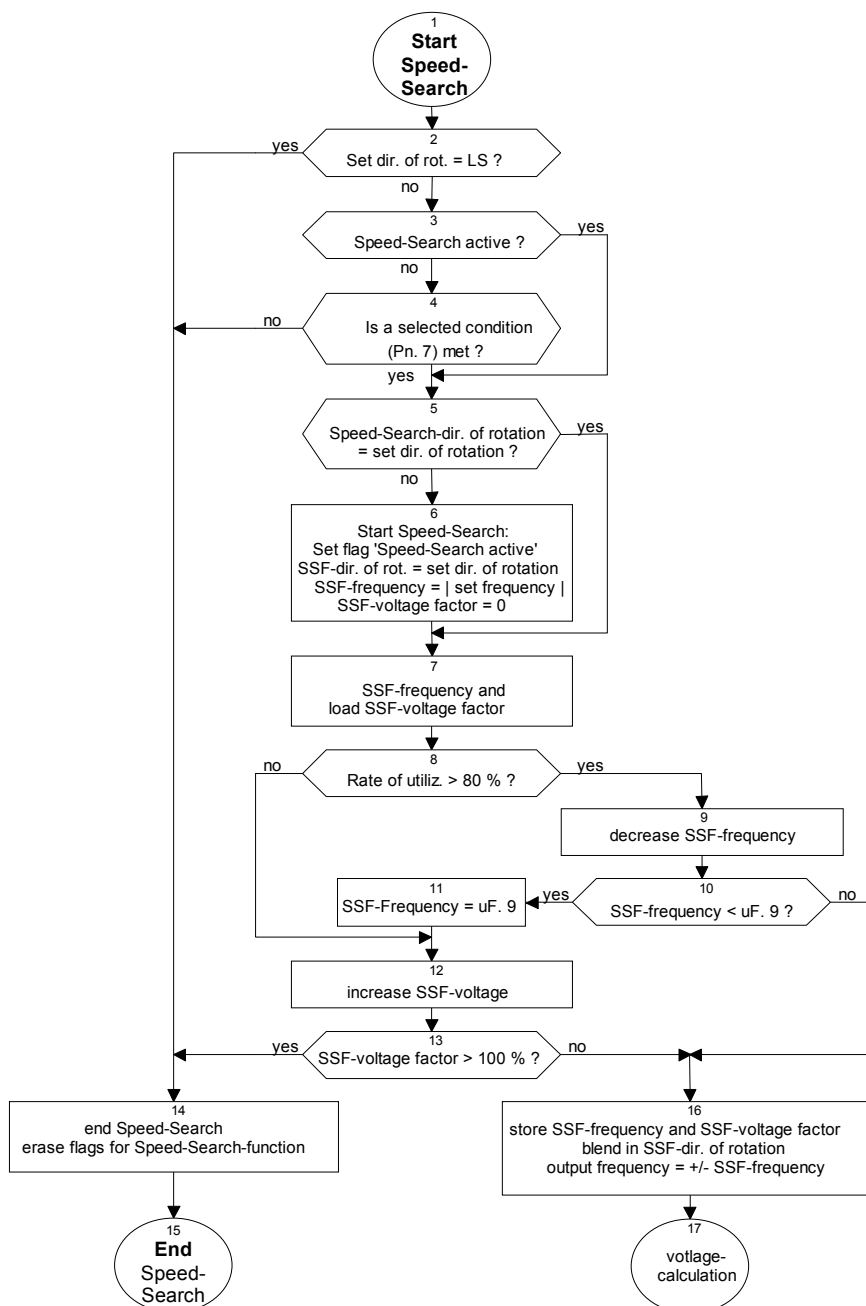

# Pn - Parameter

Speed Search  
Condition Example

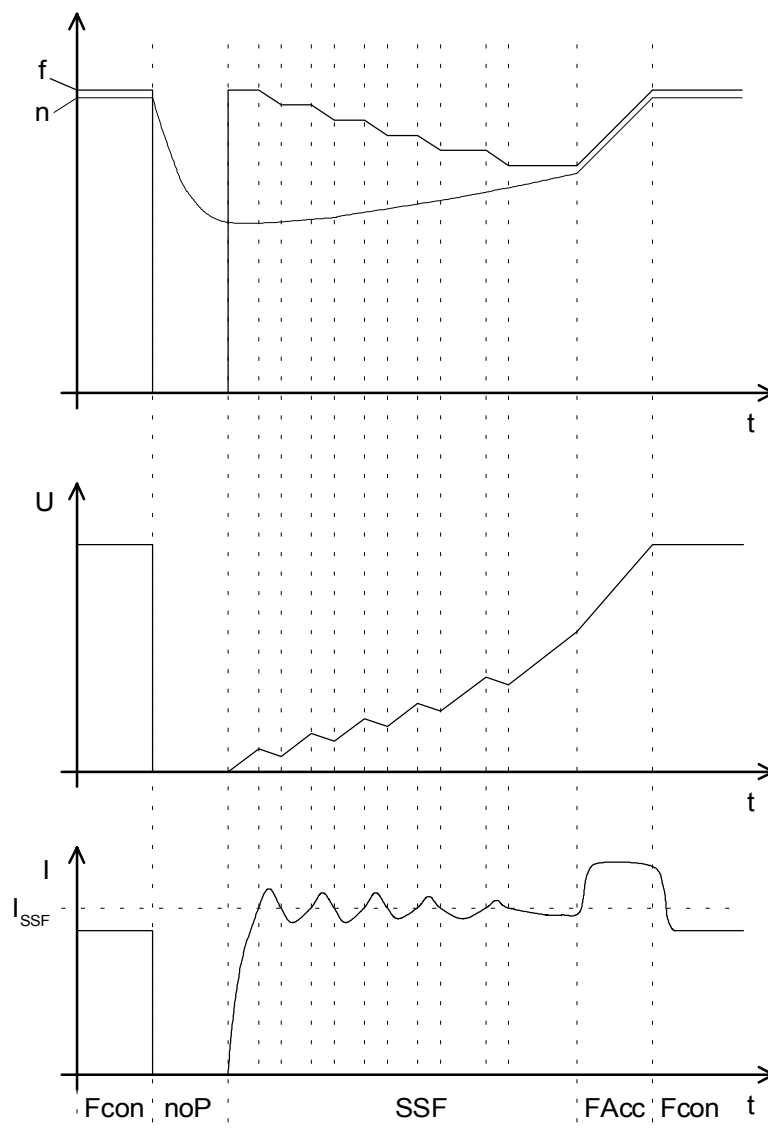

Condition at the Start of Speed		Function
actual setpoint	$\geq$ Old setpoint	safe
	$\geq$ Motor actual speed	safe
	$<$ Motor actual speed	critical
actual dir. of rot.	$=$ old dir. of rot.	safe
	$<>$ old dir. of rot.	critical



With DC-braking the motor is not decelerated by the ramp. Quick braking occurs with d.c. voltage, which is given onto the motor winding. Pn. 8 specifies, whether DC-braking is triggered.

*DC Braking Mode  
(Pn. 8)*

Value	Condition
0	No DC-braking
1	Switch off the dir. of rot. and reach $f = 0$ Hz (LS) Braking time = Pn.11, as long as no dir. of rot. is given
2	Switch off the direction of rotation Braking time = $(Pn.11 * \text{actual frequency}) / 100$ Hz
3	Change of rotation Braking time = $(Pn.11 * \text{actual frequency}) / 100$ Hz
4	Switch off the direction of rotation and actual value < DCB Start-frequency (Pn. 9) Braking time = $(Pn.11 * \text{actual frequency}) / 100$ Hz
5	Actual value < DCB Start-frequency (Pn. 9) Braking time = $(Pn.11 * \text{actual frequency}) / 100$ Hz
6	Setpoint < DCB Start-frequency (Pn. 9) Braking time = $(Pn.11 * \text{actual frequency}) / 100$ Hz Restart 1st when the setpoint > DCB Start-frequency (Pn. 9)
7	Activation of a digital input (I1 .. I2, see di. 3/4) Braking time = $(Pn.11 * \text{actual frequency}) / 100$ Hz Restart 1st, when the input is activated
8	Activation of a digital input (I1 .. I2, see di. 3/4) Braking time = time, which the input is active
9	Switch on the modulation (control release and dir. of rotation) Braking time = Pn.11

This sets the frequency level for Pn. 8 = 4 .. 6.  
Setting range: 0 .. 409.5875 Hz  
Resolution: 0.0125 Hz

*DC-Brake Start  
Frequency (Pn. 9)*

Specifies the maximum negative anode potential and d.c. voltage. The negative anode potential is, if necessary, reduced dependent on the rate of utilization.

Setting range: 0 .. 25.5 %  
Resolution: 0.1 %

*DC Brake Maximum  
Voltage (Pn.10)*

Adjustment information: When the DC brake is switched on, the load may not exceed 110% (only for a short time in the starting torque of the DC brake). The DC brake voltage (Pn.10) must be limited to max. 110% if the load exceed 110%.

The length of the braking time is dependent on the braking mode (see Pn.8). With some modes the braking time shortens and/or lengthens itself depending on the actual frequency. It is limited to max. 100 s.

*DC Braking Time  
(Pn.11)*

Setting range: 0 .. 100 s  
Resolution: 0.01 s

# Pn - Parameter

## DC-Braking Time Lapse Diagram

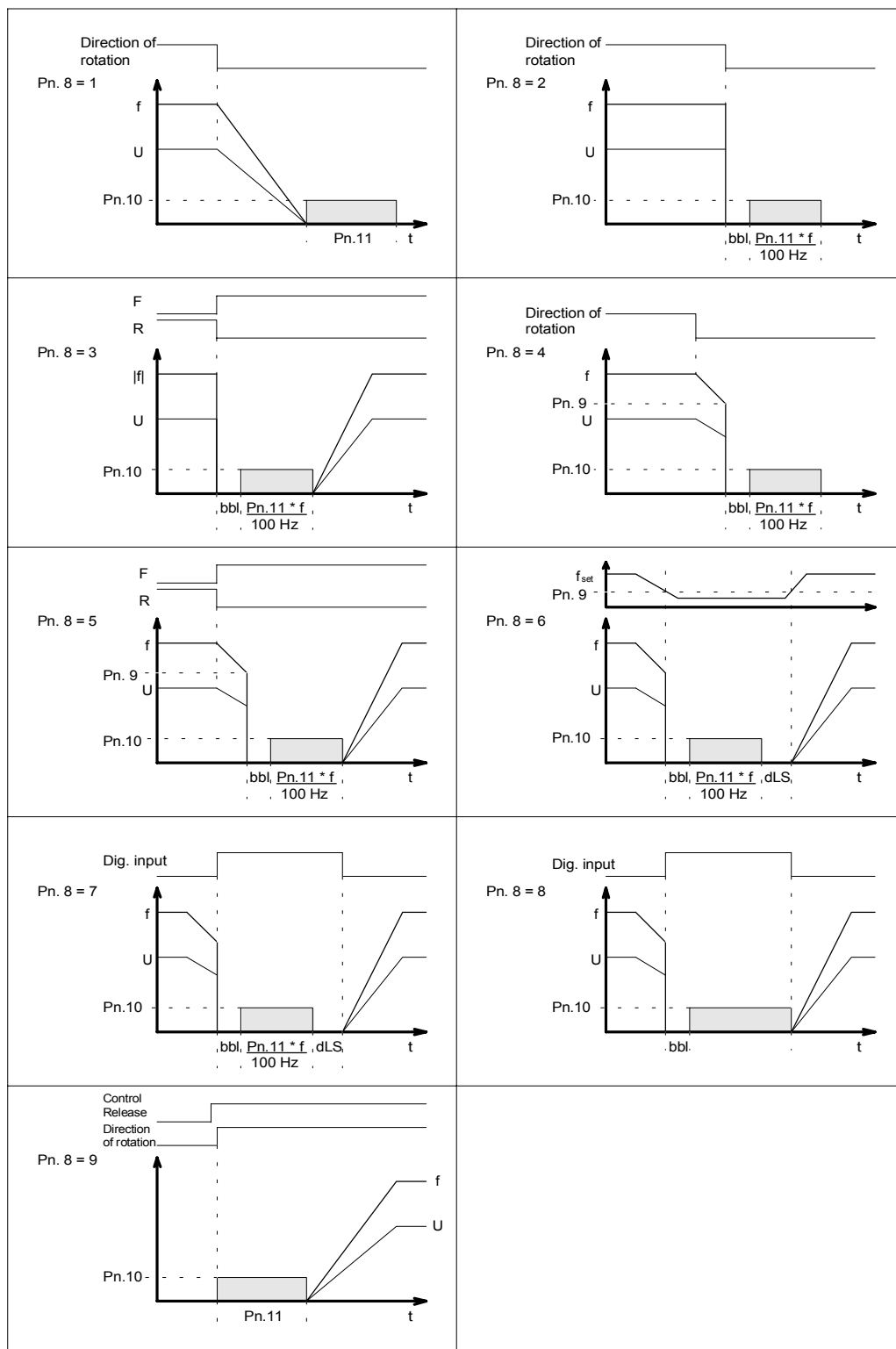

Stall ACC/DEC time  
Fow Chart  
Part 1

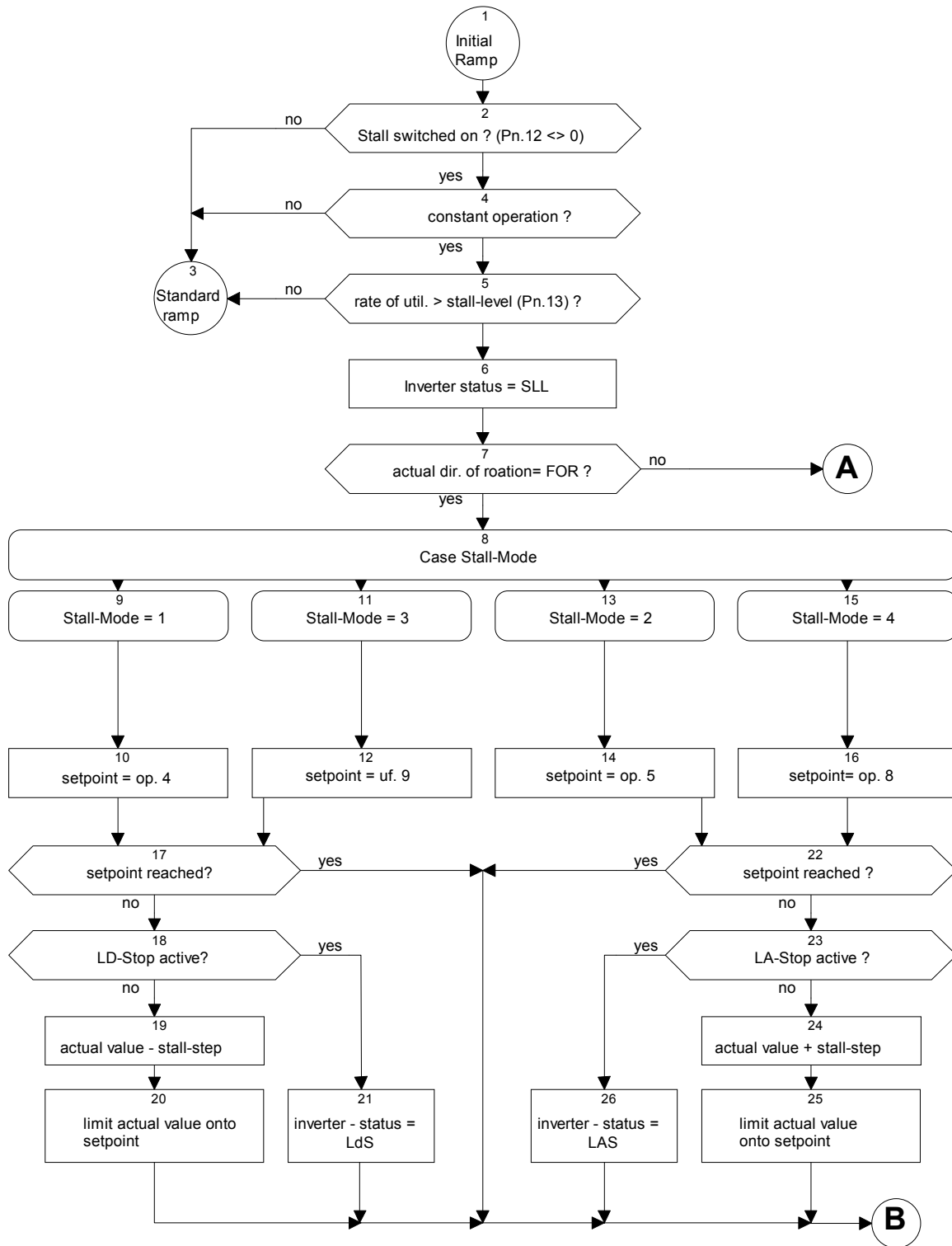

# Pn - Parameter

Stall Mode (Pn.12)  
 Stall Level (Pn.13)  
 Stall ACC/DEC  
 Time (Pn.14)

This function protects the inverter from switching off caused by overcurrent, during constant speed. Depending on the torque/speed characteristic of the connected machine, a load reduction is reached by deceleration (e.g. fan) and/or acceleration (e.g. drilling machine). The following modes can be set by Pn.12.:

Value	Mode
0	Function deactivated
1	Decelerate onto oP. 4
2	Accelerate onto oP. 5
3	Decelerate onto uF. 9
4	Accelerate onto oP. 8

In Pn.13 the comparison value for the function is set. Pn.13 is compared with the actual rate of utilization. If this is larger than Pn.13 the output frequency is changed, dependent on the set mode with the given ramp time by Pn.14. When the current limit is exceeded the inverter decelerates/accelerates with the set ramp times in oP.11/oP.12 onto the original setpoint. The function is deactivated at setpoint changes (e.g. setpoint jumps > 0.5 Hz, reverse) and at start (acceleration out LS).

Stall Mode  
 Flow Chart  
 Part 2

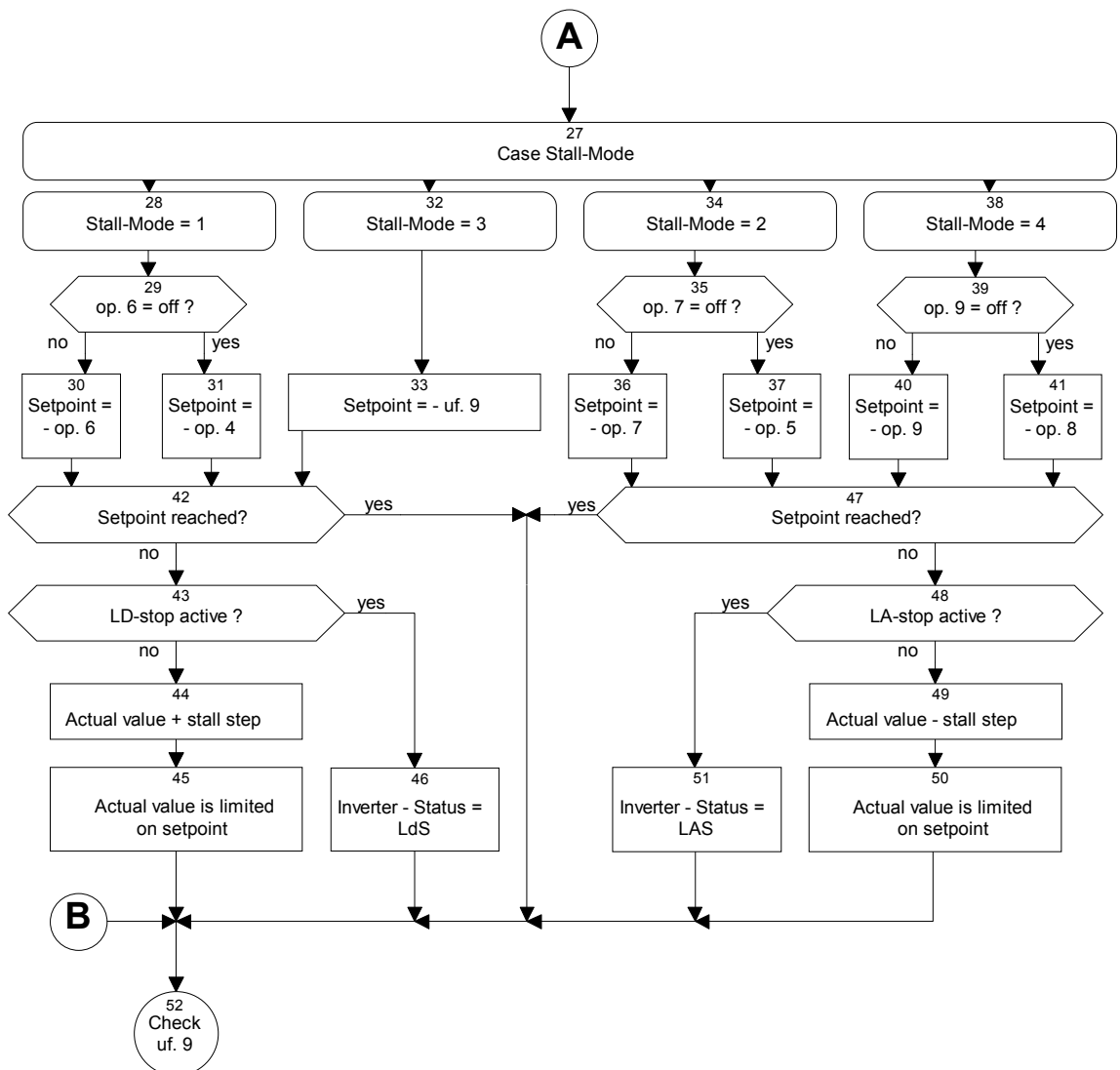

Stall Mode  
Example

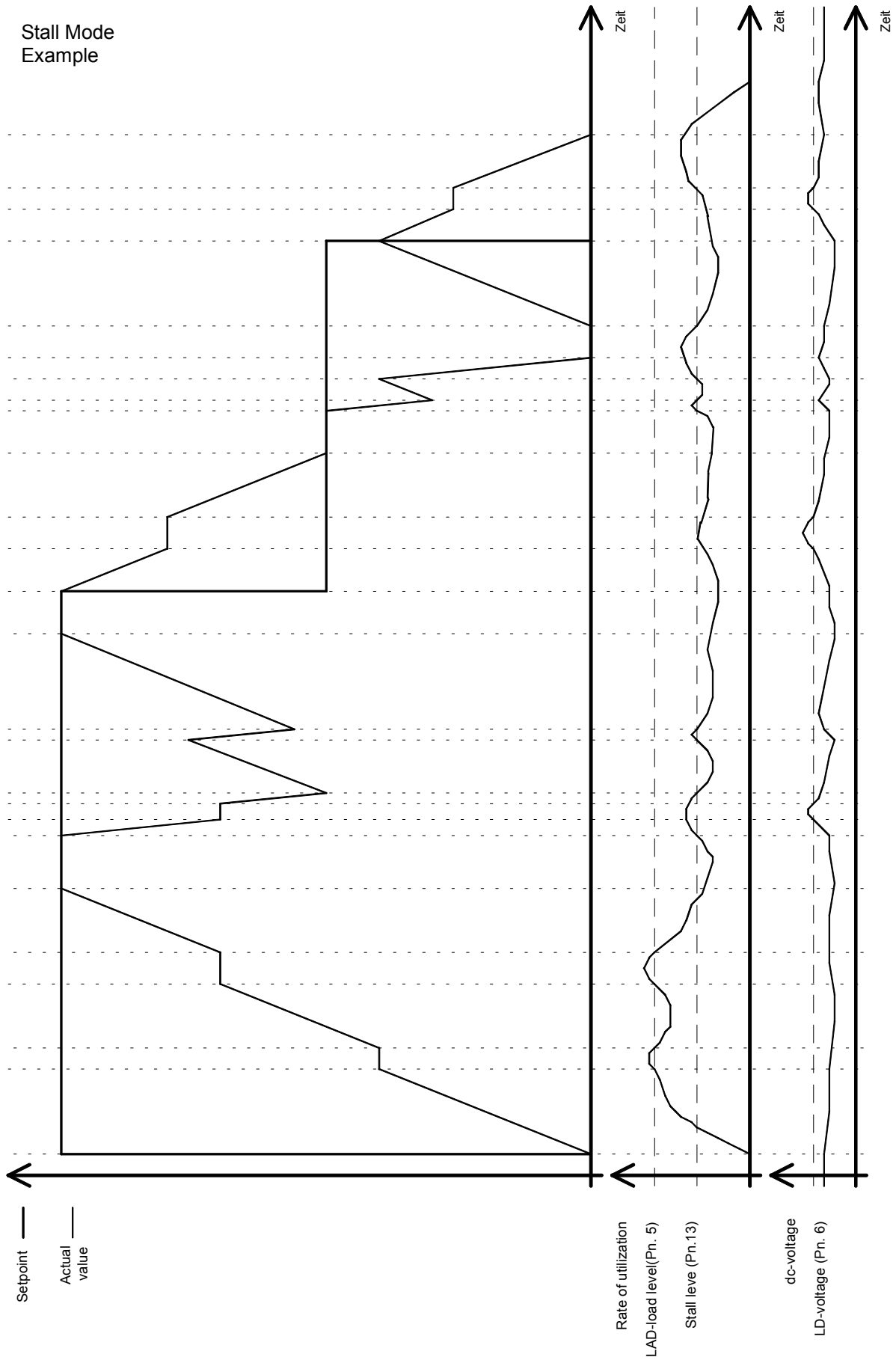

## Pn - Parameter

*E.dOH Delay Time (Pn.16)* This parameter can decelerate the triggering of the error E.dOH (overheating of the motor) after the external signal is supplied.

**5.4 Volt/Hertz - Characteristic (uF) - Parameter**

uF. 0	RATED FREQUENCY
uF. 1	BOOST
uF. 4	DELTA BOOST
uF. 5	DELTA BOOST TIME
uF. 8	DC VOLTAGE COMPENSATION
uF. 9	MINIMUM FREQUENCY FOR MODULATION
uF. 11	CARRIER FREQUENCY

*Parameter Summary*

# uF - Parameter

## Voltage/Frequency Characteristic (uF. 0, uF. 1)

The U/f - curve is adjusted with uF. 0 and uF. 1. uF.0 indicates the output frequency where an output voltage of 100% is reached. 100% output voltage means a value of  $UDC / \sqrt{2}$  when uF. 8 is switched off. With an active UDC-compensation 100% results in the adjusted output voltage and a max of  $1.05 * UDC / \sqrt{2}$ . UDC means dc-bus voltage. The dc-bus voltage results from:  $UDC = \sqrt{2} * \text{input voltage}$ . The boost specifies the output voltage at an output frequency of 0Hz. The presetting occurs as a percentage value.

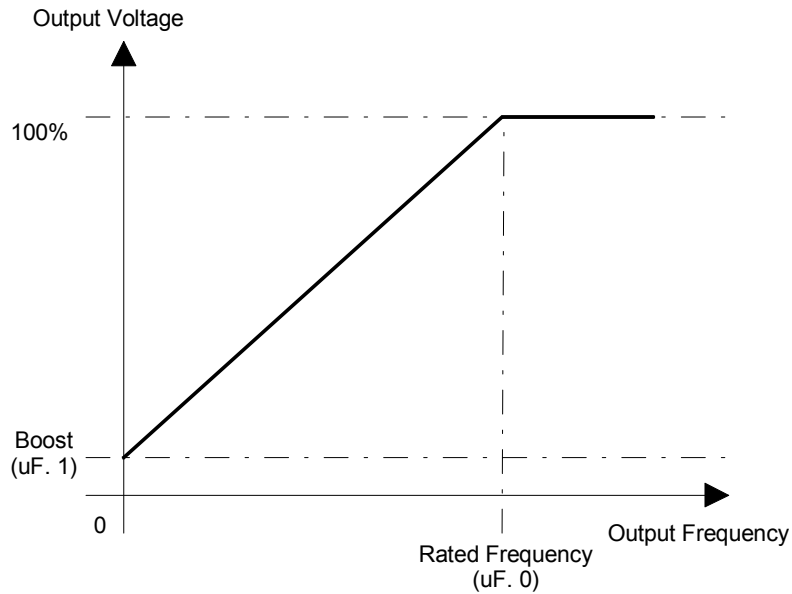

## Delta Boost (uF. 4, uF. 5)

To overcome larger breakaway torque raise the output voltage, from 0 Hz to a time set in u.5. These voltage increases are called delta boost. They are preset with a resolution of 0,1% with uF. 4. If the sum of boost + delta boost exceed a value of 25,5%, then the delta boost is internally limited to 25,5% boost.

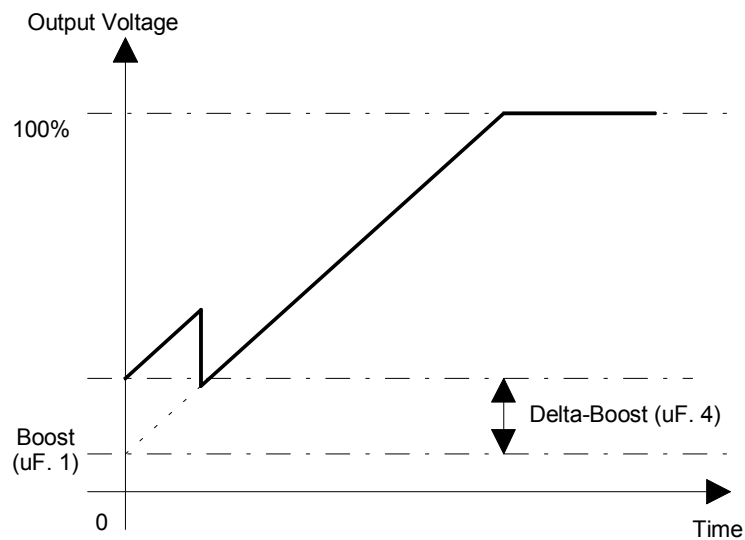



The value of the dc-bus voltage can change during operation, caused by fluctuations of the mains voltage and load variations. Since the output voltage of the inverter is directly dependent on the dc-bus voltage,

$$\text{output voltage} = \text{modulation depth (\%)} * \text{DC-voltage} / \sqrt{2}$$

these changes of the dc-bus voltage cause changes in the inverter output voltage. When DC-voltage compensation is switched on the fluctuations of the output voltage, which are produced by the change in the dc-bus voltage, are compensated. Meaning, 100% output voltage corresponds to the set voltage in uF. 8, maximum  $1.05 * \text{DC-voltage} / \sqrt{2}$ . With this it is also possible to fit the inverter onto a motor with smaller rated voltage. By entering the value 650V (oFF) the DC-voltage compensation is switched off.

*DC-Voltage  
Compensation  
(uF. 8)*

For some users (trafo) it is necessary to increase the minimum output frequency of the inverter (standard 0Hz). If a frequency > 0Hz is set in uF.9, then all output frequencies < uF. 9 are suppressed and the modulation is switched off. The acceleration and deceleration ramps start and/or end with this frequency. Hysteresis is not used to switch off/on modulation during overtravel and/or underpassing of uF. 9. Make sure that the setpoint is not in the range of uF. 9 with the analog frequency reference setting.

*Minimum Frequency  
for Modulation  
(uF. 9)*

The carrier frequency can be adjusted in grades of 1kHz to 16kHz (dependent on the power circuit).

*Carrier Frequency  
(uF.11)*



### 5.5 Drive (dr) Parameter

dr. 1	RATED MOTOR SPEED
dr. 2	RATED MOTOR CURRENT
dr. 3	RATED MOTOR FREQUENCY
dr. 4	RATED MOTOR COS (phi)
dr. 5	MOTOR TERMINAL RESISTANCE
dr. 12	RATED MOTOR VOLTAGE

*Parameter Summary*

## dr - Parameter

<i>dr - Parameter</i>	The input of the correct motor data is important for many inverter functions, since calculations are derived from it, which the inverter requires in order to achieve the best possible results in torque- and slip compensation.
<i>Rated Motor Speed (dr. 1)</i>	Input of the rated motor speed as directed in the type plate of the motor.
<i>Rated Motor Current (dr. 2)</i>	Input of the rated motor current as directed in the type plate of the motor.
<i>Rated Motor Frequency (dr. 3)</i>	Input of the rated motor frequency as directed in the type plate of the motor.
<i>Rated Motor cos(phi) (dr. 4)</i>	Input of the rated motor cos (phi) as directed in the type plate of the motor.
<i>Motor Terminal Resistance (dr. 5)</i>	Input of the ohmic resistance between 2 phases, measured at the beginning of the motor cable. The wiring of the motor (star, delta) must be the same as in operation. Use suitable measuring instruments!
<i>Rated Motor Voltage (dr. 12)</i>	Input of the rated motor voltage as directed in the type plate of the motor.

## 5.6 Control (cn) - Parameter

cn. 0	CONTROL MODE
cn. 1	SLIP COMPENSATION GAIN
cn. 2	TORQUE COMPENSATION GAIN

*Parameter Summary*

*Control Mode*  
(cn. 0)

Activates the torque compensation (Autoboost) and slip compensation.

Value	Function	Note
0	Controller off	
1	Autoboost on	
2	Slip compensation on	not useful
3	Autoboost and slip compensation on	

*Slip Compensation*  
(cn. 1)

Determines the amplification of the frequency change.

*Torque Compensation*  
(cn. 2)

Determines the amplification of the voltage change (Auto-Boost).

## 5.7 User Definition (ud) - Parameter

*Parameter Summary*

ud. 0	KEY PASSWORD INPUT
ud. 1	BUS PASSWORD INPUT
ud. 2	START PARAMETER GROUP
ud. 3	START PARAMETER NUMBER
ud. 4	AUTO ENTER
ud. 6	INVERTER ADDRESS
ud. 7	BAUD RATE
ud. 11	MAXIMUM FREQUENCY MODE
ud. 13	CP0 ADDRESS
ud. 14	CP0 SET
ud. 15	CP1 ADDRESS
ud. 16	CP1 SET DEFINITION
ud. 17	CP2 ADDRESS
ud. 18	CP2 SET DEFINITION
ud. 19	CP3 ADDRESS
ud. 20	CP3 SET DEFINITION
ud. 21	CP4 ADDRESS
ud. 22	CP4 SET DEFINITION
ud. 23	CP5 ADDRESS
ud. 24	CP5 SET DEFINITION
ud. 25	CP6 ADDRESS
ud. 26	CP6 SET DEFINITION
ud. 27	CP7 ADDRESS
ud. 28	CP7 SET DEFINITION
ud. 29	CP8 ADDRESS
ud. 30	CP8 SET DEFINITION
ud. 31	CP9 ADDRESS
ud. 32	CP9 SET DEFINITION
ud. 33	CP10 ADDRESS
ud. 34	CP10 SET DEFINITION
ud. 35	CP11 ADDRESS

ud. 36	CP11 SET DEFINITION
ud. 37	CP12 ADDRESS
ud. 38	CP12 SET DEFINITION
ud. 39	CP13 ADDRESS
ud. 40	CP13 SET DEFINITION
ud. 41	CP14 ADDRESS
ud. 42	CP14 SET DEFINITION
ud. 43	CP15 ADDRESS
ud. 44	CP15 SET DEFINITION
ud. 45	CP16 ADDRESS
ud. 46	CP16 SET DEFINITION
ud. 47	CP17 ADDRESS
ud. 48	CP17 SET DEFINITION
ud. 49	CP18 ADDRESS
ud. 50	CP18 SET DEFINITION
ud. 51	CP19 ADDRESS
ud. 52	CP19 SET DEFINITION
ud. 53	CP20 ADDRESS
ud. 54	CP20 SET DEFINITION
ud. 55	CP21 ADDRESS
ud. 56	CP21 SET DEFINITION
ud. 57	CP22 ADDRESS
ud. 58	CP22 SET DEFINITION
ud. 59	CP23 ADDRESS
ud. 60	CP23 SET DEFINITION



When a password is entered you can switch between each parameter level. The parameter levels set by ud.0 only apply to the inputs via keyboard and LED-display. The independent parameter levels for operation with serial interface or with Dual-Port-Ram protocol are preset by parameter ud.1. The parameters are:

*Key Password  
Input (ud. 0)*

Password	Password Levels
100	CP - READ ONLY
200	CP - ON
440	APPLICATION
500	DRIVE - MODE

The significance of each password level is described in Chapter 4.4 „Password Structure“.

When the FUNCT key is pressed and there is a change into ud.0, then the current password level is shown first. To enter a new password use the UP/DOWN key. The new password must be confirmed with ENTER. Thereafter the actual password level is shown again.

The keyboard password can also be preset by the serial interface. This input is the same as the input via keyboard. This means that after setting the password with bus the LED display shows the actual keyboard password level and changes to ud.0 and/or cP.0 by confirming FUNCT.

Presets the password levels for operation with serial interface and/or Dual-Port-Ram protocol.

*Bus Password  
Input (ud. 1)*

Password levels CP-ON, APPLICATION and SUPERVISOR are possible. The passwords and the significance of the password levels are the same as those of the keyboard password. The bus password is not visible during keyboard operation.

The start parameters select the parameter, which is displayed after the inverter is switched on. In ud.2 the desired parameter group is set and in ud.3 the desired parameter number. The parameter set is always set at 0. If a parameter is set in ud.3 that does not exist, the inverter starts with the next highest parameter number.

*Start Parameter  
(ud. 2 , ud. 3)*

When the inverter is switched on a password level < 3 is active, meaning display of the user defined parameter groups. The setting of ud.2 is ignored. ud.3 then specifies the parameter number of the cP-parameter, whose value should be displayed at start-up. If this parameter is not available, then cP.0 is shown.

The parameter storage (EEPROM) of the unit does not permit an unlimited number of write cycles. To increase the life expectancy of the parameter memory set ud.4 at 0 (**AUTO-SAVE**).

*AUTO ENTER  
(ud.4)*

Thereafter all parameters written via Bus are **not** stored!

Switching off the parameter storage is only necessary when the inverter continuously receives new parameters via bus and exceeds the maximum number (1 million) of write cycles.

Note: Parameter changes done via keyboard are always stored!

## ud - Parameter

*Inverter Address  
(ud. 6)*

ud.6 sets the address. This address communicates to the inverter "COMBIVIS" or another control. Values between 0 and 239 are possible and the standard value = 1. When several inverters are simultaneously operated by bus it is absolutely necessary to assign them different addresses. If this is not done communication disturbances can occur because, under certain circumstances, several inverters may respond. For further information see the description of DIN 66019 protocol.

*Baud Rate (ud. 7)*

The following values for the baud rate of the serial interface are possible:

Parameter Value	Baud Rate
0	1200 baud
1	2400 baud
2	4800 baud
3	9600 baud
4	19200 baud

If the value for the baud rate is changed by the serial interface, then it can only be changed again via keyboard or after adapting the baud rate of the master, since no communication is possible when master and slave have different baud rates.

*Maximum Frequency  
Mode (ud.11)*

ud.11 can switch the output frequency range from 400 Hz (ud.11 = 0) to 800 Hz (ud.11=1). The resolution of the setpoints changes in the 800 Hz mode from 0.0125 Hz to 0.025 Hz. Changes are first active after the Power-On reset.

*Definition of  
Customer  
Parameters  
(ud.13 - ud.60)*

The parameter of the customer specified parameter group (cP) *can't* be change by the user.  
(Parameter address and parameter set see table ud-parameter).

## 5.8 Free-programmable (Fr) Parameter

Fr. 0	COPY PARAMETER SET (KEYBOARD)
Fr. 1	COPY BUS PARAMETER SET
Fr. 2	PARAMETER SET SOURCE
Fr. 3	PARAMETER SET LOCK
Fr. 4	PARAMETER SET SETTING
Fr. 9	BUS PARAMETER SET

*Parameter Summary*

# Fr - Parameter

## Copy Sets (Fr. 0, Fr. 1)

It is possible to copy the complete set instead of adjusting each set separately. This means all parameter values of the target set are written over by the corresponding parameter values of the source set. All sets 0 - 3 are possible as target sets. For source sets, the sets 0 - 3, **def** and **init**. **def** copy the basic adjustments stored in EPROM into the target set. **init** copies the basic adjustment into all sets, independent from the target set. If the target set is not 0, then only the programmed parameters are copied, since the non-programmable parameters only exist in set 0. If the source set is neither **0** nor **def** or **init**, then only the programmed parameters can be copied.

The following limitations are valid for copying sets:

1. The default set, **def**, cannot be copied into the momentary active set. This may only be done when the inverter is in **noP**, **LS** or **E. XX** (error).
2. **init** can only be completed with **noP**, **LS** or **E. XX** (error).
3. The source set may not be the same as the target set.
4. The target set may not be adjusted at the display of the current set **A**.

## Keyboard (Fr. 0)

When using the keyboard the copying process is triggered by Fr.0. Fr.0 is not visible in Bus. The parameter value specifies the source set. The target set is the parameter set in which Fr.0 is edited (parameter set in the display of the parameter name). Pressing ENTER triggers the copying process. If it could not be completed **nco** appears in the display. This feedback must be confirmed with ENTER.

## Bus (Fr. 1)

In bus the copying process is triggered by Fr.1. Fr.1 is not visible by keyboard. The parameter value specifies the source set, the target set is specified by Fr.9.

## Parameter Set Source (Fr. 2)

Each parameter set can be activated in a different manner. Possible sources for the parameter set selection are:

Parameter Value	Set Selection
0	Set selection deactivated (always set 0)
1	Set selection with Fr. 4
2	Set selection with terminal strip binary coded
3	Set selection with terminal strip input coded

In the deactive parameter set selection, the inverter always operates with the adjusted value in set 0.

If the digital set selection is adjusted, then the set in which the inverter is operated, is adjusted in Fr.4. The presetting can be done via keyboard as well as by Bus.

When the active set is selected by the terminal strip, then Fr.2 must be set at 2 or 3. The desired input terminals must also be programmed onto the set selection (di 3/4).

Input		Active Set	
I2 (X1.5)	I1 (X1.4)	Fr.2 = 2	Fr.2 = 3
0	0	0	0
0	16..24V	1	1
16..24V	0	2	2
16...24V	16...24V	3	1

Parameter sets, which should not be selected, can be locked by Fr.3. If a locked set is selected, then the set selection error (E.SET) is triggered. Fr.3 is bit coded. If several sets should be locked, then the sum of the decimal value is formed.

*Parameter Set Lock  
(Fr. 3)*

Bit -No.	Decimal Value	Set Blocked
0	1	0
1	2	1
2	4	2
3	8	3

With Fr.4 the parameter set (0 to 3) can be preset by Bus or keyboard, when the digital set selection is adjusted (Fr. 2 = 1).

*Parameter Set  
Setting (Fr. 4)*

Specifies the parameter set, which is edited by Bus. It does not necessarily correspond to the active set, in which the inverter is currently running! The following adjustments are possible:

*Bus Parameter Set  
(Fr. 9)*

Value	Function
-1 (A)	Parameter value of the currently active set is shown. Parameter values cannot be changed.
0	Parameter values from set 0 are shown.
1	Parameter values from set 1 are shown.
2	Parameter values from set 2 are shown.
3	Parameter values from set 3 are shown.



**5.9 Analog I/O (An) - Parameter**

An. 7	NOISE FILTER REF2
An. 8	ZERO CLAMP REF2
An. 9	REF2 GAIN
An. 10	REF2 OFFSET X
An. 11	REF2 OFFSET Y
An. 14	ANALOG OUT1 FUNCTION
An. 15	ANALOG OUT 1 GAIN
An. 16	ANALOG OUT 1 OFFSET X
An. 17	ANALOG OUT 1 OFFSET Y

*Parameter Summary*

Flow Chart  
Analog In-/Outputs

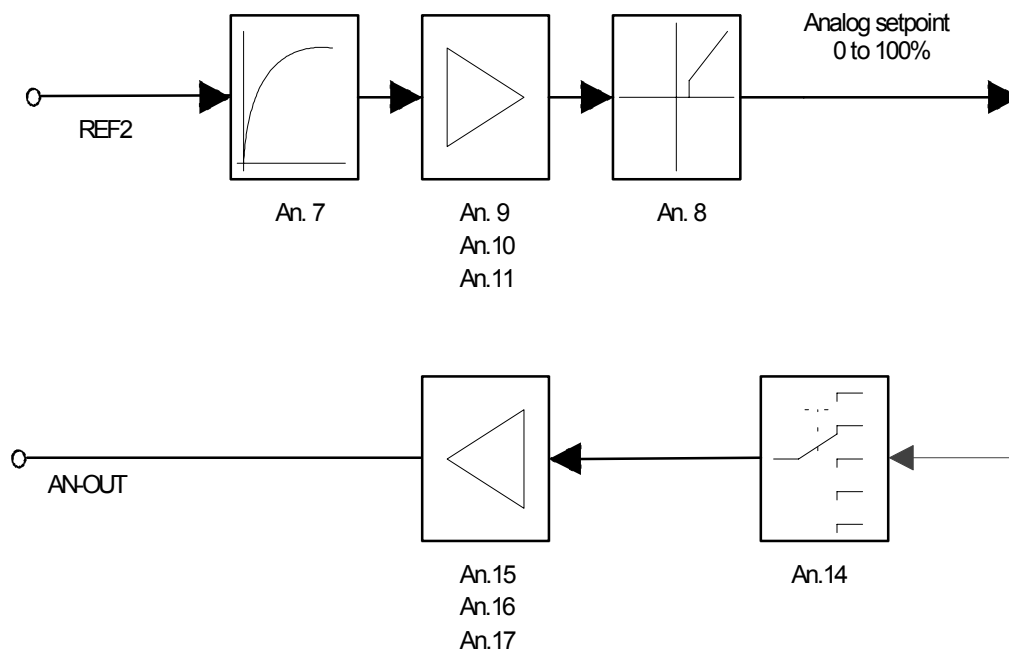

Noise Filter REF2  
(An. 7)

These parameters activate a smoothing of the input signal. As a result disturbances and ripples can be suppressed. The averaging causes the smoothing. The averaging has a sample raster of 4ms. The following smoothings are adjustable:

Parameter Value	Averaging
0	No averaging (actualization time 4ms)
1	Averaging with 2 values (actualization time 8ms)
2	Averaging with 4 values (actualization time 16ms)
3	Averaging with 8 values (actualization time 32ms)
4	Averaging with 16 values (actualization time 64ms)

With actualization time, the continuous time of the averaging is designated.

Curve Gain of the  
Analog Inputs and  
Outputs  
(An.9 - An.11,  
An.15 - An.17)

The analog input REF supplies an input value of 100% at +10V. The analog output supplies a voltage of 10V when the output value is 100%. These curves are influenced by the 2 curve gains An.9,10,11(REF) and An.14,15,16 (ANOUT1).



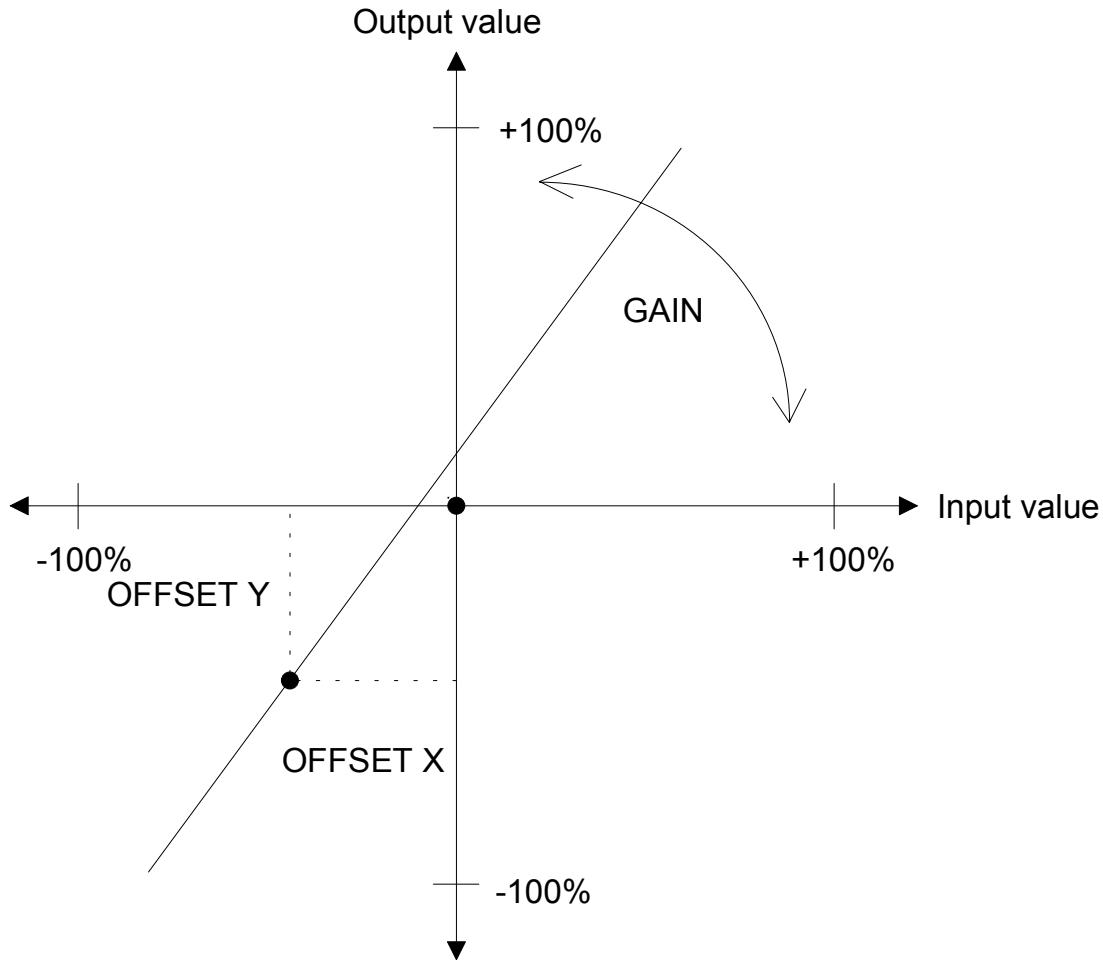

With offset X (An.10, An.16) and Offset Y (An.11, An.17) the zero point of the curve can be specified. In most applications it is enough to adjust one of the two parameters. The increase of the curve is specified by the gain (An. 9, An.15).

With these parameters a zero point hysteresis is adjusted for the analog input. Voltage fluctuations and hum voltages at the zero point are suppressed (output of the curve gain!).

*Zero Clamp  
REF2 (An. 8)*

The size can be selected by An.14 , which should be displayed by the analog output.

*Analog Out1  
Function (An.14)*

Parameter Value	Process Size	Value Range
0	Actual frequency	100% = 100Hz
1	Rate of utilization	100% = 200/150/125%
2	Set frequency	100% = 100Hz
3	Output voltage	100% = max. voltage (500 V)
4	d.c. voltage	100% = 810V / 405V
5	Effective Current	100% = 2*In / 1.5 *In / 1.25 *In
6	Actual frequency	100% = 100Hz
7	Digital output	off = 0 / on = 10V



### 5.10 Digital Input (di) - Parameter

di. 0	NOISE FILTER DIGITAL
di. 2	INPUT LOGIC
di. 3	INPUT FUNCTION I1
di. 4	INPUT FUNCTION I2
di. 14	INPUT TRIGGER
di. 15	SELECT SIGNAL SOURCE
di. 16	DIGITAL INPUT SETTING
di. 17	INPUT STROBE DEPENDENT
di. 18	SELECT STROBE SOURCE
di. 19	SELECT STROBE MODE
di. 20	ROTATION INPUT

*Parameter Summary*

# di - Parameter

## Input Process

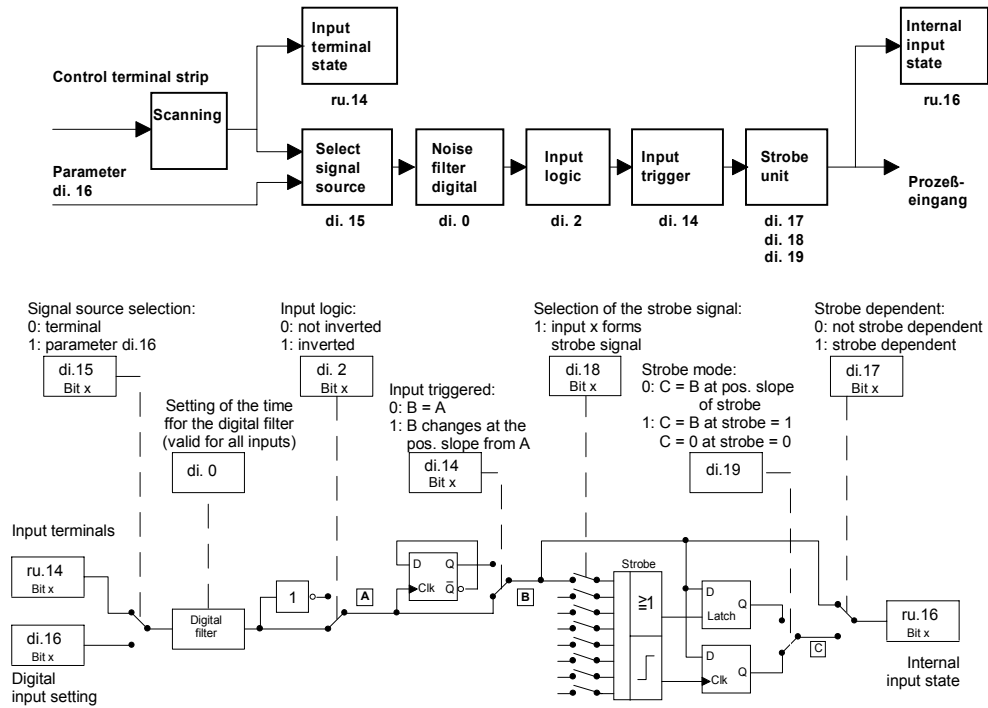

In general all parameters are preset, so that the input signal (digitally filtered) directly passes through.

## Noise Filter Digital (di. 0)

The digital filter reduces the sensitivity to disturbances at the control inputs. di.0 adjusts the reaction time of the inputs. During the reaction time a constant input state must be at **all** inputs, before a signal is accepted as valid.

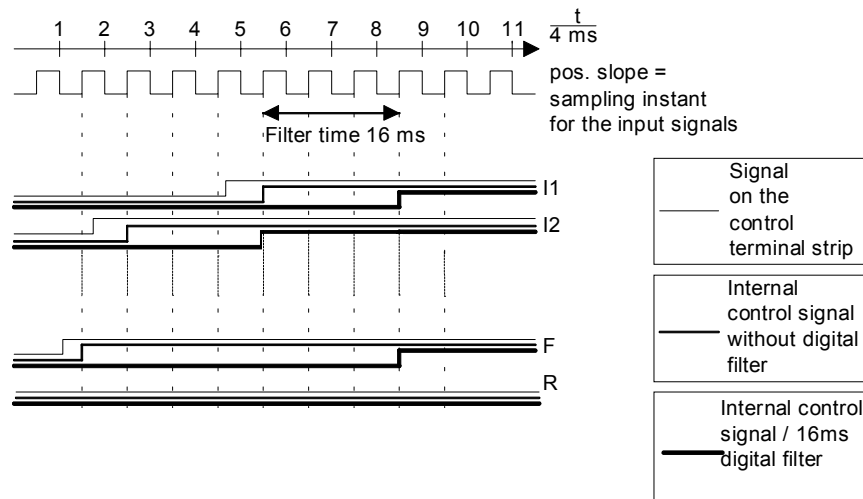

In each of these parameters, in which the respective function should be activated, the respective decimal value is adjusted. If the function should be valid for several inputs, then the sum of the decimal values is adjusted. For the input ST there are exceptions, which is described in each parameter. The following assignments are valid.

*Bit Coded  
Parameters  
di. 2, di.14 - di.18*

Bit - No.	Decimal Value	Input
0	1	ST
1	2	RST
2	4	F
3	8	R
4	16	I1
5	32	I2

This parameter adjusts, whether input signal 1 or 0 is active (inverted).  
Input ST is always 1!

*Input Logic  
(di. 2)*

These parameters adjust the function of the programmable inputs (I1 - I2).

*Input Functions  
(di. 3, di. 4)*

Parameter Value	Input Function
0	no function
1	input used for set selection
2	reset for set selection
3	input activates DC - braking
4	no function
5	input activates LAD stop
6	input triggers external errors (E. EF)
7	no function
8	no function
9	input used for step speed switch over (is only available with I1 and I2).

Specifies, whether the the input signal can directly be re-processed (condition evaluated), or whether the internal state changes with every positive slope (at the output of the logic selection!) of the input (input active).  
Input ST is not input dependent!

*Input Trigger  
(di.14)*

In di.15 it can be selected for each input, whether the state of the control terminal or the state of parameter di.16 is evaluated.

*Select Signal  
Source (di.15)*

In di.16 the inputs can be set by the software. For this the corresponding inputs must be selected in di.16.

*Digital Input  
Setting (di.16)*

Attention:

The input ST is an exception. In case the digital presetting of the control release is adjusted (Bit 0 from di.15 = 1), then the signal must be preset by the terminal strip **and** by the parameter di.16 (Bit 0).

## di - Parameter

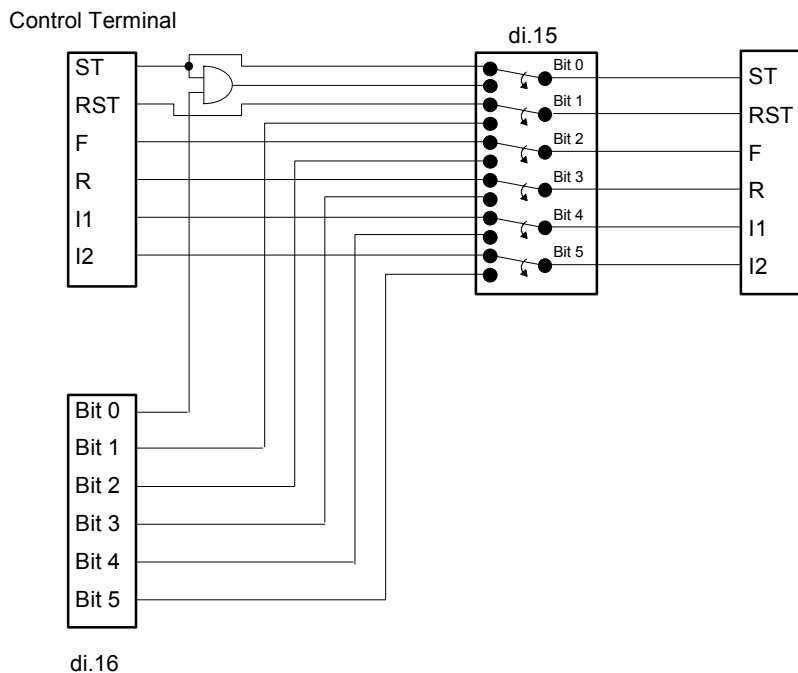

*Input Strobe  
Dependent  
(di.17)*

Specifies which inputs are dependent on the strobe signal. Strobe dependent inputs are only actualized with valid strobe signals.

**Attention: Input ST is not strobe dependent!**

*Select Strobe  
Source (di.18)*

Specifies which inputs signals make up the strobe signal. All parameters with this signal are or-interconnected. The selection as strobe signal does not influence the selected function in the input function

Determines the strobe mode.

Select Strobe Mode (di.19)

Parameter Value	Strobe Mode
0	The current input state is stored with the positive slope of the strobe signal.
1	As long as the strobe signal is inactive, then all the input signals are inactive. When the strobe signal is active, then the input signals are accepted.

di.19 = 0 :

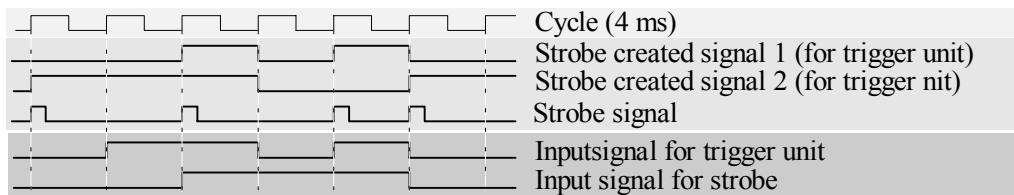

di.19 = 1 :

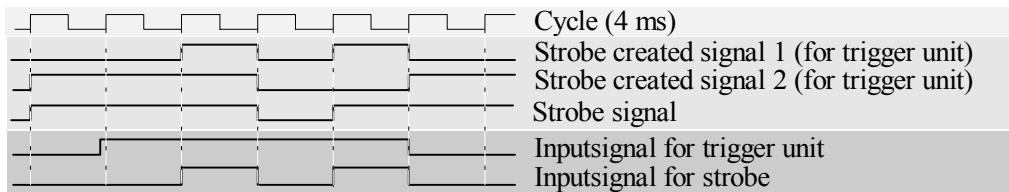

di.20 specifies the operational mode of signals F and R (rotation presetting by terminal).

Rotation Input (di.20)

di.20 = 1:

Terminal F	Terminal R	Direction of Rotation
0	0	LS
0	1	Reverse
1	0	Forward
1	1	Forward

di.20 = 0:

Terminal F	Terminal R	Direction of Rotation
0	0	LS
0	1	LS
1	0	Forward
1	1	Reverse





### 5.11 Digital Output (do) - Parameter

do. 0	OUTPUT LOGIC
do. 1	OUTPUT CONDITION 1
do. 2	OUTPUT CONDITION 2
do. 9	SELECT OUT1 CONDITION
do. 10	SELECT OUT2 CONDITION
do. 17	OUT1 CONDITION LOGIC
do. 18	OUT2 CONDITION LOGIC 2
do. 25	OUT CONDITION CONNECTION

*Parameter Summary*

## do - Parameter

### Output Logic (do. 0)

do.0 makes it possible to invert the digital outputs. The parameter is bit coded.

Bit-No.	Decimal Value	Output	Terminal
0	1	Out 1 (analog Out)	10
1	2	Out 2 (Relay RLA,RLB,RLC)	1 , 2 , 3

For every output that should be inverted, the respective decimal value is adjusted. If both outputs should be inverted, then the sum of the decimal values (3) is adjusted

### Output Condition 1 - 2 (do. 1 - do. 2)

These parameters set the output conditions, which are assigned to the outputs Out 1 - Out 2 with parameters do.9 - do.25:

Value	Function of the Output
0	always inactive
1	always active
2	alarm relay
3	alarm relay (not during active Auto-Restart-function)
4	overload-pre-warning (see also LE.32)
5	overtemperature pre-warning inverter (Warning when the inverter-temperature sensor is triggered, error after xx sec.)
6	temperature detector (PTC) pre-warning (warning when the motor-PTC is triggered, error after the Pn.16 has run).
7	always active
8	stall
9	LA-/LD-Stop
10	dc-braking
11	always active
12	rate of utilization (ru. 7) > rate of utilization level (LE. 8 .. LE.10(15))
13	active current (ru.10) > active current level (LE.16 .. LE.18(23))
14	actual value = set value (ru. 0 = Fcon, rcon; not at noP, LS, error, SSF)
15	accelerate (ru. 0 = FAcc, rAcc, LAS)
16	decelerate (ru. 0 = FdEc, rdEc, LdS)
17	forward (not at noP, LS, error)
18	reverse (not at noP, LS, error)
19	actual direction of rotation = set direction of rotation
20	actual value   > frequency level (LE. 0 .. LE. 2(7), LE.36)
21	setpoint   > frequency level (LE. 0 .. LE. 2(7), LE.36)
22	always inactive
23	run signal (ru. 0 <> error)
24	operating signal (modulation active)

### Select Condition (do. 9 - do.10) Condition Logic (do.17 - do.18)

To activate the output condition for the respective output the prevailing decimal value in the parameter "Selection of output condition Out X" is set. The state of the output condition is displayed in parameter ru.17. Each output condition can be inverted by setting the respective decimal value in the parameter "Logic of the output conditions Out X".

Bit-No.	Decimal Value	Output Conditions
0	1	1
1	2	2

There may be several conditions valid for the output. In this case, the sum of the decimal value must be set.

Specifies whether the input conditions, which are selected for an output, will be interconnected with an AND-interconnection (Bit X = 1) or with an OR-interconnection (Bit X = 0).

*Out Condition  
Connection (do.25)*

Bit - No.	Decimal Value	Output
0	1	Out 1
1	2	Out 2

#### Conditions for the output Out 1:

Actual direction of rotation = set direction of rotation and rate of utilization < 80 %

*Examples of  
do. 0 - do. 25*

#### Conditions for the output Out 2:

Rate of utilization > 80 % or actual value <> set value

#### Settings:

##### 1. Output conditions

do. 1 = 19 (Actual direction of rotation = set direction of rotation)

do. 2 = 12 (rate of utilization > rate of utilization level)

LE. 9 = 80 %

##### 2. Selection of the output conditions

do. 9 (Out 1) = 3 (bit 0 and bit 1 set => cond. 1 and cond. 2 active)

do.10 (Out 2) = 6 (bit 1 and bit 2 set => cond. 2 and cond. 3 active)

##### 3. Logic of the output conditions

do.17 (Out 1) = 2 (bit 1 set => cond. 2 inverted)

do.18 (Out 2) = 4 (bit 2 set => cond. 3 inverted)

##### 4. Interconnection of the output conditions

do.25 = 2 (Bit 0 = 1 => cond. for Out 1 are interconnected AND)

Bit 1 = 0 => cond. for Out 2 are interconnected OR)

##### 5. Logic of the digital outputs

do. 0 = 0 (the outputs are not inverted)

Output Processing

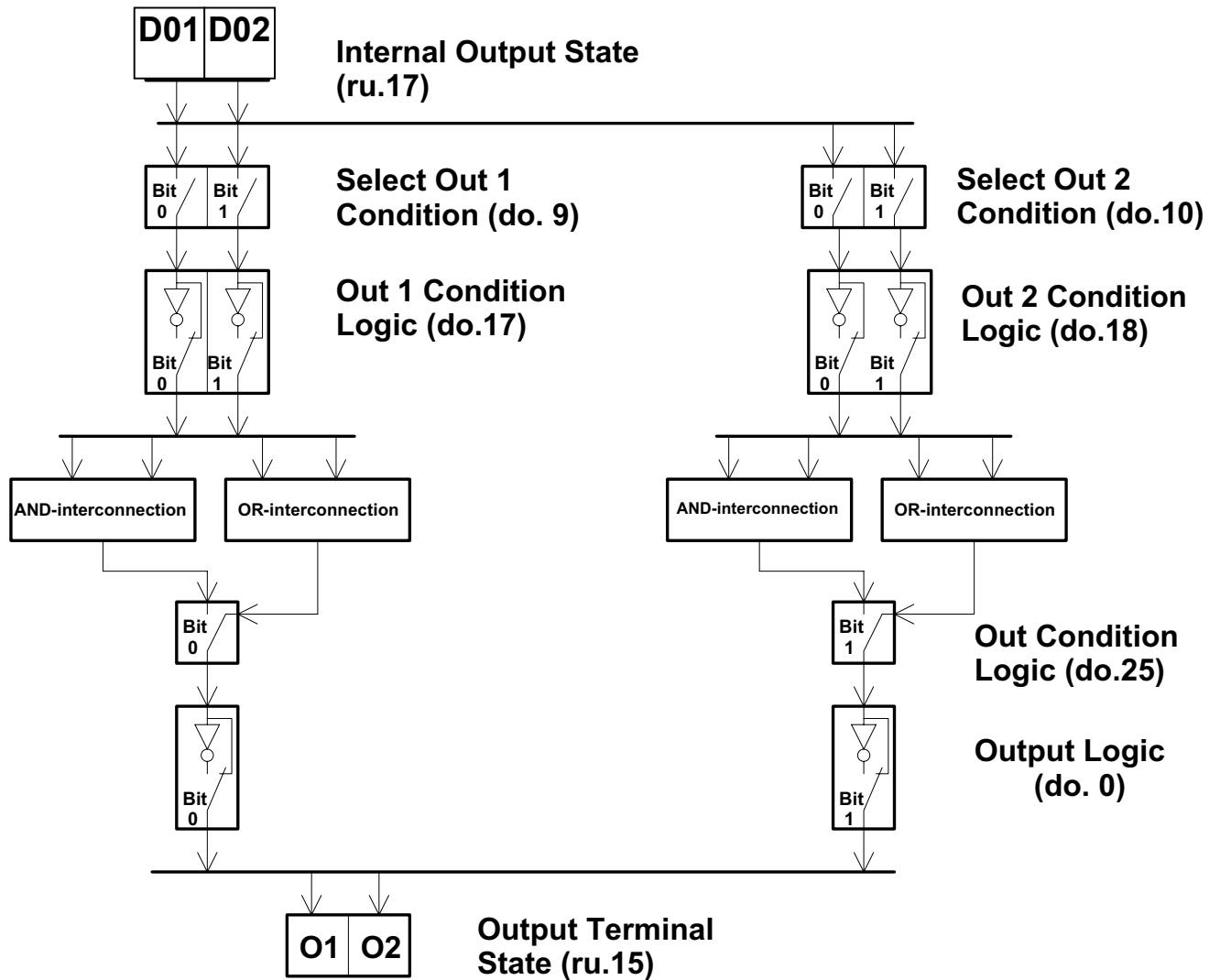

Switching Behaviour  
of the digital outputs

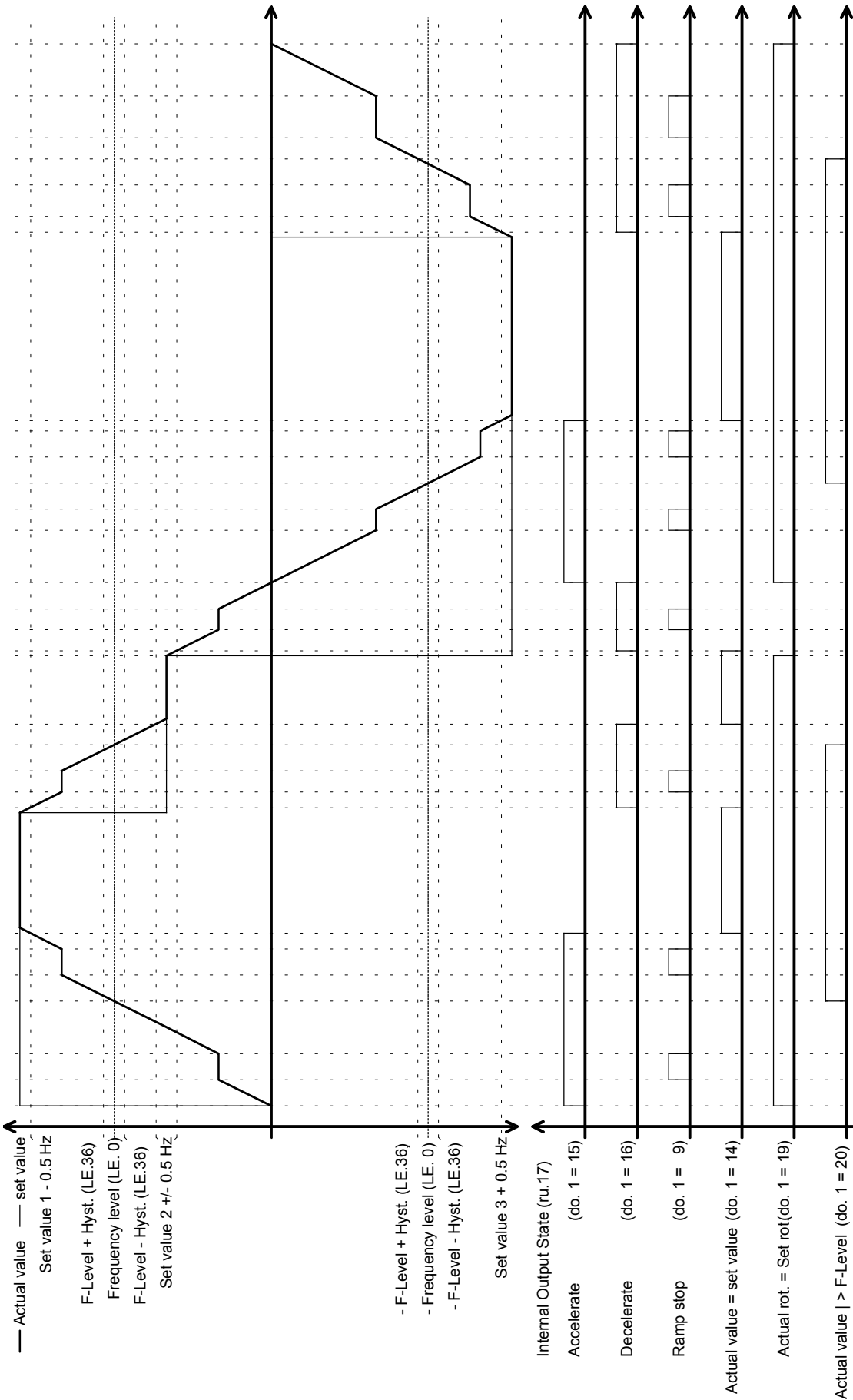

Interconnection and Display of the Digital in-/outputs

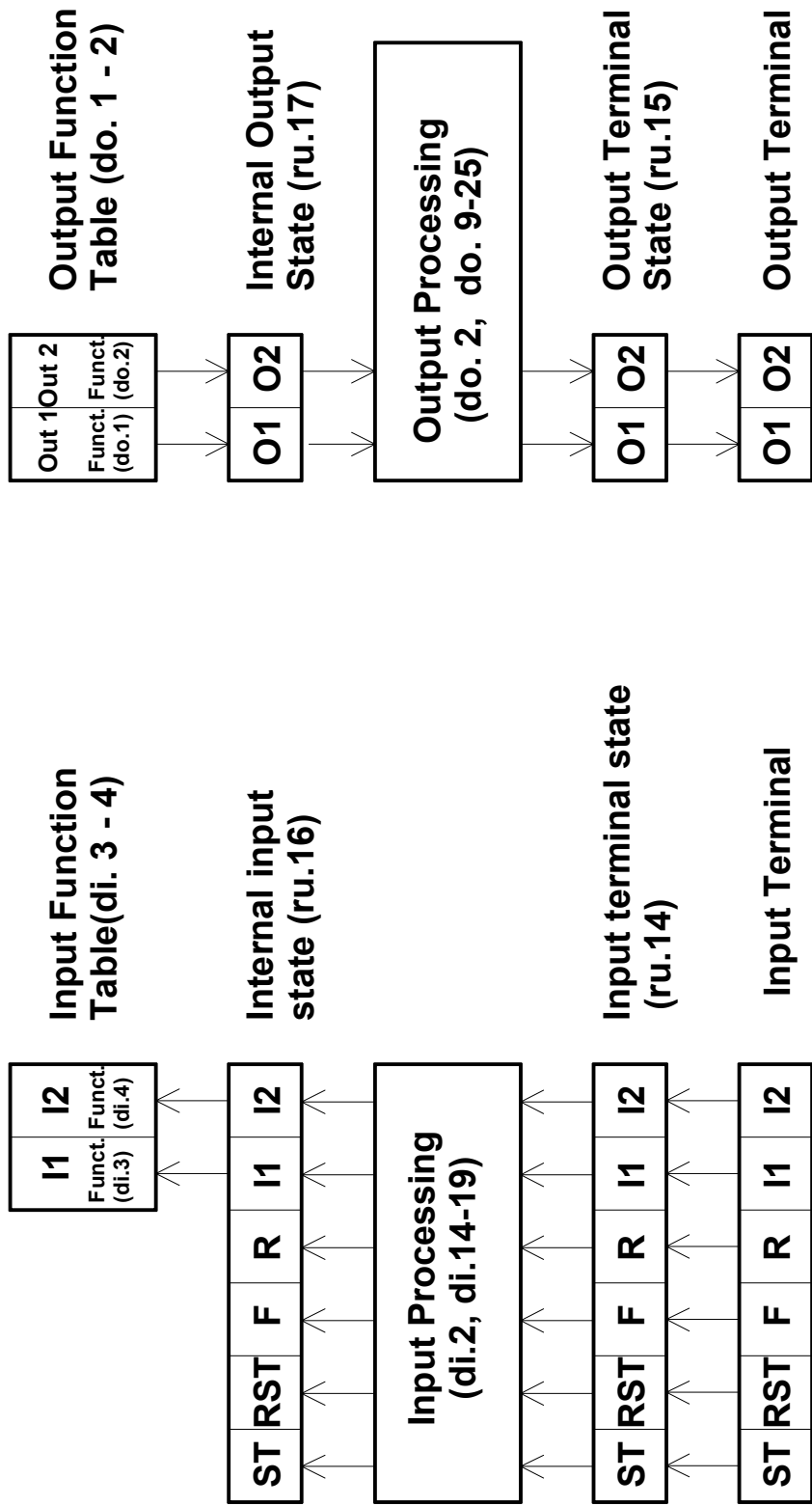

**5.12 Level (Le) - Parameter**

LE. 0	FREQUENCY LEVEL 1
LE. 1	FREQUENCY LEVEL 2
LE. 8	LOAD LEVEL 1
LE. 9	LOAD LEVEL 2
LE. 16	ACTIVE CURRENT LEVEL 1
LE. 17	ACTIVE CURRENT LEVEL 2
LE. 32	OL-WARNING LEVEL
LE. 36	FREQUENCY HYSTERESIS

*Parameter Summary*

## LE - Parameter

<i>Frequency Level 1 -2 (LE. 0 - LE.2) Frequency Hysteresis (LE.36)</i>	<p>The frequency levels are the comparison values for the frequency dependent output conditions of the digital outputs. The frequency level is valid for both directions of rotation. Frequency level 1 is valid for output condition 1 etc. The frequency hysteresis specifies the switching hysteresis.</p> <p>Value range: 0 ... 409.5875 Hz Resolution: 0.0125 Hz</p>
<i>Load Levels 1 - 2 (LE. 8 - LE.9)</i>	<p>These parameters are the comparison values for the dependent rate of utilization output conditions of the digital outputs. The loading level is valid for output condition 1 etc.</p> <p>Value range: 0 ... 200 % Resolution: 1 %</p>
<i>Active Current Level 1 -2 (LE.16 - LE.17)</i>	<p>These parameters are the comparison values for the dependent active current output condition of the digital outputs. Active current level 1 is valid for output condition 1 etc.</p> <p>Value range: 0 ... 370 A Resolution: 0.1 A</p>
<i>OL - Warning Level (LE.32)</i>	<p>If the OL-counter (ru.24) 100% is reached, then the error E.OL is triggered. LE.32 is the comparison value for the output condition "OL-Warning Level".</p> <p>Value range: 0 ... 100 % Resolution: 1 %</p>



### 5.13 Information (In) - Parameter

*Parameter Summary*

In. 0	INVERTER TYPE
In. 1	RATED INVERTER CURRENT
In. 2	MAX. OUTPUT FREQUENCY
In. 3	MAX. CARRIER FREQUENCY
In. 4	SOFTWARE - VERSION
In. 5	SOFTWARE - DATE
In. 6	CONFIGFILE-NO.
In. 7	SERIAL NO. ( DATE )
In. 8	SERIAL NO. ( COUNTER )
In. 9	SERIAL NO. ( AB. NO. HIGH )
In. 10	SERIAL NO. ( AB.NO. LOW )
In. 11	CUSTOMER NUMBER ( HIGH )
In. 12	CUSTOMER NUMBER ( LOW )
In. 13	QS - NUMBER
In. 40	LAST ERROR
In. 41	ERROR COUNTER OC
In. 42	ERROR COUNTER OL
In. 43	ERROR COUNTER OP
In. 44	ERROR COUNTER OH

# In - Parameter

*Inverter Type  
(In. 0)*

The inverter type is displayed as a hexal decimal number. Each bit has the following meaning.

bit 0:	Voltage class	0 = 230V 1 = 400V
bit 1-5	Unit size	05,07,09,....
bit 6-9	Control type	0 = 0A.F4 ( F4-C / up to housing E ) 1 = 0B.F4 ( F4-S / up to housing E ) 2 = 00.F4 ( F4-C / as of housing G )
bit 10-12	Nominal switching frequency	0 = 2kHz 1 = 4kHz 2 = 6kHz 3 = 8kHz 4 = 10kHz 5 = 12kHz 6 = 14kHz 7 = 16kHz
bit 13-15	Maximum switching frequency	0 = 2kHz 1 = 4kHz 2 = 6kHz 3 = 8kHz 4 = 10kHz 5 = 12kHz 6 = 14kHz 7 = 16kHz

Example:

hex	2	4	4	7
binary	0 0 1 0	0 1 0 0	0 1 0 0	1 1 1 0
decimal	1	1	1	7 0

=> 07.F4.S 4 / 14kHz / 200V

*Rated Inverter  
Current (In. 1)*

Display of the rated inverter current in A (resolution 0.1 A).

*Max. Output  
Frequency (In. 2)*

Display of the maximum possible output frequency in Hz (resolution 0.0125 Hz).

*Max. Carrier  
Frequency (In. 3)*

Display of the maximum possible output frequency in kHz (resolution 1 kHz).

*Software-Version  
(In. 4)*

The software version number and the control hardware are coded in this parameter.  
 Position 1: Control hardware (0 = 00.F4, A = 0A.F4, B = 0B.F4)  
 Position 2 + 3: Software version (e.g. 11 = 1.1)  
 Position 4: Special version (0 = standard)

Display of the software-date. The value consists of the day, month and year, but only the last digit of the year is shown.

*Software-Date  
(In. 5)*

Example:       Display = 1507.4  
                  Date    = 15.07.94

In.6 contains a software identifier which is needed by KEB COMBIVIS to select the correct configfile. The configuration automatically occurs when COMBIVIS is activated and the inverter is connected.

*Configfile-Number  
(In. 6)*

The serial number and the customer number identify the inverter. The QS-number contains product internal information.

*Serial Number  
Customer Number  
(In. 7 - In.12),  
QS-Number (In.13)*

In.40 shows the last error that occurred. E.UP is not stored.

*Last Error  
(In.40)*

Error counters (for E.OC, E.OL, E.OP, E.OH) specify the number of the total errors which occur of the prevailing type. The maximum value is 255.

*Error Counters  
(In.40 - In.44)*



## 6 Parameter Tables

### 6.1 ru-Parameter

Group	No.	Name	Adr. (hex)	P	E	ro	Res.	Lower Limit	Upper Limit	Default Value	Unit
ru	0	Inverter State	2000			•	table				
ru	3	Actual Frequency Display	2003			•	0,0125	-409,58	409,58		Hz
ru	6	Set Frequency Display	2006			•	0,0125	-409,58	409,58		Hz
ru	7	Actual Inverter Utilization	2007			•	1	0	200		%
ru	8	Peak Inverter Utilization	2008				1	0	200		%
ru	9	Apparent Current	2009			•	0,1				A
ru	10	Active Current	200A			•	0,1				A
ru	11	Actual DC Voltage	200B			•	1				V
ru	12	Peak DC Voltage	200C				1				V
ru	13	Output Voltage	200D			•	1	0			V
ru	14	Input Terminal State	200E			•	table				
ru	15	Output Terminal State	200F			•	table				
ru	16	Internal Input State	2010			•	table				
ru	17	Internal Output State	2011			•	table				
ru	18	Actual Parameter Set	2012			•	table				
ru	23	REF 2 Display	2017			•	0,1	0	100		%
ru	24	OL Counter Display	2018			•	1	0	100		%
ru	29	Heat Sink Temperature	201D			•	1				°C

**P = Programmable**

*(In each set the parameter can have another value)*

**E = Enter**

*(The parameter value is active after the Enter-key is pressed)*

**ro = read only**

*(The parameter can't be changed)*

## 6.2 oP-Parameter

Size	No.	Name	Adr. (hex)	P	E	ro	Res.	Lower Limit	Upper Limit	Default Value	Unit
oP	0	Frequency Reference Source	2100	•	•		1	0	8	1	
oP	1	Frequency Reference Setting Absolute	2101	•			0,0125	-409,58	409,58	0	Hz
oP	2	Frequency Reference Setting	2102	•			0,1	-100	100	0	%
oP	3	Rotation Setting	2103	•	•		1	0	2	0	
oP	4	Minimum Reference	2104	•			0,0125	0	409,58	0	Hz
oP	5	Maximum Reference	2105	•			0,0125	0	409,58	70	Hz
oP	8	Absolute Maximum Frequency	2108	•			0,0125	0	ln. 2	409,58	Hz
oP	11	Acceleration Time	210B	•			0,01	0	300	10	s
oP	12	Deceleration Time	210C	•			0,01	0	300	10	s
oP	22	Step Frequency 1	2116	•			0,0125	-409,58	409,58	5	Hz
oP	23	Step Frequency 2	2117	•			0,0125	-409,58	409,58	50	Hz
oP	24	Step Frequency 3	2118	•			0,0125	-409,58	409,58	70	Hz
oP	25	Step Frequency Mode	2119	•			1	0	3	2	

### 6.3 Pn-Parameter

Size	No.	Name	Adr. (hex)	P	E	ro	Res.	Lower Limit	Upper Limit	Default Value	Unit
Pn	0	Automatic Retry UP	2200				1	0	1	1	
Pn	1	Automatic Retry OP	2201				1	0	1	0	
Pn	2	Automatic Retry OC	2202				1	0	1	0	
Pn	4	LAD Stop Function	2204	•			1	0	7	1	
Pn	5	LAD Load Level	2205	•			1	10	200	140	%
Pn	6	LD Voltage	2206	•			1	200	800	750/375	V
Pn	7	Speed Search Condition	2207	•			1	0	15	8	
Pn	8	DC Braking Mode	2208	•			1	0	9	7	
Pn	9	DC Brake Start Frequency	2209	•			0,0125	0	409,5875	4	Hz
Pn	10	DC Brake Maximum Voltage	220A	•			0,1	0	25,5	25,5	%
Pn	11	DC Braking Time	220B	•			0,01	0	100	10	s
Pn	12	Stall Mode	220C	•			1	0	4	1	
Pn	13	Stall Level	220D	•			1	10	200	200	%
Pn	14	Stall ACC/DEC Time	220E	•			0,01	0	300	10	s
Pn	16	E.dOH Delay Time	2210				1	0	120	60	s

### 6.4 uF-Parameter

Size	No.	Name	Adr. (hex)	P	E	ro	Res.	Lower Limit	Upper Limit	Default Value	Unit
uF	0	Rated Frequency	2300	•			0,0125	0	409,58	50	Hz
uF	1	Boost	2301	•			0,1	0	25,5	2	%
uF	4	Delta Boost	2304	•			0,1	0	25,5	0	%
uF	5	Delta Boost Time	2305	•			0,01	0	10	0	s
uF	8	DC Voltage Compensation	2308	•	•		1	150	650 : off	650 : off	V
uF	9	Minimum Frequency For Modulation	2309	•			0,0125	0	409,58	0	Hz
uF	11	Carrier Frequency	230B	•			1	1	ln. 3 (16)	4	kHz

## 6.5 dr-Parameter

Size	No.	Name	Adr. (hex)	P	E	ro	Res.	Lower Limit	Upper Limit	Default Value	Unit
dr	1	Rated Motor Speed	2401	•			1	0	32767	1500	rpm
dr	2	Rated Motor Current	2402	•			0,1	0	370	7,5	A
dr	3	Rated Motor Frequency	2403	•			0,0125	0	409,58	50	Hz
dr	4	Rated Motor Cos (phi)	2404	•			0,01	0,5	1	0,8	
dr	5	Motor Terminal Resistance	2405	•			0,01	0	max	0	Ohm
dr	12	Rated Motor Voltage	240C	•			1	150	500	400	V

## 6.6 cn-Parameter

Size	No.	Name	Adr. (hex)	P	E	ro	Res.	Lower Limit	Upper Limit	Default Value	Unit
cn	0	Control Mode	2500	•			1	0	3	3	
cn	1	Slip Compensation Gain	2501	•			0,01	-2,5	2,5	0	
cn	2	Torque Compensation Gain	2502	•			0,01	-2,5	2,5	0	



## 6.7 ud-Parameter

Size	No.	Name	Adr. (hex)	P	E	ro	Res.	Lower Limit	Upper Limit	Default Value	Unit
ud	0	Key Password Input	2600		•		1	0	9999	0	
ud	1	Bus Password Input	2601				1	0	9999	0	
ud	2	Start Parameter Group	2602				table	ru	table	ru	
ud	3	Start Parameter Number	2603				table	0	99	1	
ud	4	Auto Enter (only for Bus parameters)	2604				1	0 : off	1 : on	1	
ud	6	Inverter Address	2606		•		1	0	239	1	
ud	7	Baud Rate	2607		•		table	1200	19200	9600	baud
ud	11	Maximum Frequency Mode	260B				1	0	1	0	

The paramters ud.13 - ud.60 are not visible in the display!

Size	No.	Name	Adr. (hex)	P	E	ro	Res.	Lower Limit	Upper Limit	Default Value	Unit
ud	13	cP0 Address	260D			•	1	0	9999	2601h	
ud	14	cP0 Satz	260E			•	1	0	3 : A	0	
ud	15	cP1 Address	260F			•	1	-1 : off	7FFF	2003h	
ud	16	cP1 Set	2610			•	1	0	3 : A	0	
ud	17	cP2 Address	2611			•	1	-1 : off	7FFF	2000h	
ud	18	cP2 Set	2612			•	1	0	3 : A	0	
ud	19	cP3 Address	2613			•	1	-1 : off	7FFF	2007h	
ud	20	cP3 Set	2614			•	1	0	3 : A	0	
ud	21	cP4 Address	2615			•	1	-1 : off	7FFF	2008h	
ud	22	cP4 Set	2616			•	1	0	3 : A	0	
ud	23	cP5 Address	2617			•	1	-1 : off	7FFF	2300h	

## Parameter Tables

Size	No.	Name	Adr. (hex)	P	E	ro	Res.	Lower Limit	Upper Limit	Default Value	Unit
ud	24	cP5 Set	2618				1	0	3 : A	0	
ud	25	cP6 Address	2619				1	-1 : off	7FFF	2301h	
ud	26	cP6 Set	261A				1	0	3 : A	0	
ud	27	cP7 Address	261B				1	-1 : off	7FFF	210Bh	
ud	28	cP7 Set	261C				1	0	3 : A	0	
ud	29	cP8 Address	261D				1	-1 : off	7FFF	210Ch	
ud	30	cP8 Set	261E				1	0	3 : A	0	
ud	31	cP9 Address	261F				1	-1 : off	7FFF	2104h	
ud	32	cP9 Set	2620				1	0	3 : A	0	
ud	33	cP10 Address	2621				1	-1 : off	7FFF	2105h	
ud	34	cP10 Set	2622				1	0	3 : A	0	
ud	35	cP11 Address	2623				1	-1 : off	7FFF	2116h	
ud	36	cP11 Set	2624				1	0	3 : A	0	
ud	37	cP12 Address	2625				1	-1 : off	7FFF	2117h	
ud	38	cP12 Set	2626				1	0	3 : A	0	
ud	39	cP13 Address	2627				1	-1 : off	7FFF	2118h	
ud	40	cP13 Set	2628				1	0	3 : A	0	
ud	41	cP14 Address	2629				1	-1 : off	7FFF	2205h	
ud	42	cP14 Set	262A				1	0	3 : A	0	
ud	43	cP15 Address	262B				1	-1 : off	7FFF	220Dh	
ud	44	cP15 Set	262C				1	0	3 : A	0	
ud	45	cP16 Address	262D				1	-1 : off	7FFF	2207h	
ud	46	cP16 Set	262E				1	0	3 : A	0	
ud	47	cP17 Address	262F				1	-1 : off	7FFF	2308h	
ud	48	cP17 Set	2630				1	0	3 : A	0	
ud	49	cP18 Address	2631				1	-1 : off	7FFF	2501h	
ud	50	cP18 Set	2632				1	0	3 : A	0	
ud	51	cP19 Address	2633				1	-1 : off	7FFF	2502h	
ud	52	cP19 Set	2634				1	0	3 : A	0	
ud	53	cP20 Address	2635				1	-1 : off	7FFF	2208h	
ud	54	cP20 Set	2636				1	0	3 : A	0	
ud	55	cP21 Address	2637				1	-1 : off	7FFF	220Bh	
ud	56	cP21 Set	2638				1	0	3 : A	0	
ud	57	cP22 Address	2639				1	-1 : off	7FFF	2A03h	
ud	58	cP22 Set	263A				1	0	3 : A	0	
ud	59	cP23 Address	263B				1	-1 : off	7FFF	2B02h	
ud	60	cP23 Set	263C				1	0	3 : A	0	

### 6.8 Fr-Parameter

Size	No.	Name	Adr. (hex)	P	E	ro	Res.	Lower Limit	Upper Limit	Default Value	Unit
Fr	0	Copy Parameter Set	2700		•		1	-2 / init	3	0	
Fr	1	Copy BUS Parameter Set	2701				1	-2 / init	3	0	
Fr	2	Parameter Set Source	2702		•		1	0	3	0	
Fr	3	Parameter Set Lock	2703		•		1	0	15	0	
Fr	4	Parameter Set Setting	2704		•		1	0	3	0	
Fr	9	Bus Parameter Set	2709				1	0	3	0	

### 6.9 An-Parameter

Size	No.	Name	Adr. (hex)	P	E	ro	Res.	Lower Limit	Upper Limit	Default Value	Unit
An	7	REF2 Noise Filter	2807				1	0	4	0	
An	8	REF2 Zero Clamp	2808				0,1	0	10	0,2	%
An	9	REF2 Gain	2809				0.01	-20	20	1,00	
An	10	REF2 Offset X	280A				0,1	-100	100	0,0	%
An	11	REF2 Offset Y	280B				0,1	-100	100	0,0	%
An	14	Analog Out1 Function	280E	•	•		1	0	7	0	
An	15	Analog Out 1 Gain	280F	•			0,01	-20	20	1,00	
An	16	Analog Out 1 Offset X	2810	•			0,1	-100	100	0,0	%
An	17	Analog Out 1 Offset Y	2811	•			0,1	-100	100	0	%

### 6.10 di-Parameter

Size	No.	Name	Adr. (hex)	P	E	ro	Res.	Lower Limit	Upper Limit	Default Value	Unit
di	0	Noise Filter Digital	2900				1	0	31	0	
di	2	Input Logic	2902		•		1	0	63	0	
di	3	Input Function I1	2903		•		1	0	9	9	
di	4	Input Function I2	2904		•		1	0	9	9	
di	14	Input Trigger	290E		•		1	0	63	0	
di	15	Select Signal Source	290F		•		1	0	63	0	
di	16	Digital Input Setting	2910		•		1	0	63	0	
di	17	Input Strobe Dependent	2911		•		1	0	63	0	
di	18	Select Strobe Source	2912		•		1	0	63	0	
di	19	Select Strobe Mode	2913		•		1	0	1	0	
di	20	Rotation Input	2914		•		1	0	1	1	

## 6.11 do-Parameter

Size	No.	Name	Adr. (hex)	P	E	ro	Res.	Lower Limit	Upper Limit	Default Value	Unit
do	0	Output Logic	2A00	•	•		1	0	3	0	
do	1	Output Condition 1	2A01	•	•		1	0	24	14	
do	2	Output Condition 2	2A02	•	•		1	0	24	2	
do	9	Select Out 1 Condition	2A09	•	•		1	0	3	2	
do	10	Select Out 2 Condition	2A0A	•	•		1	0	3	1	
do	17	Out 1 Condition Logic	2A11	•	•		1	0	3	0	
do	18	Out 2 Condition Logic	2A12	•	•		1	0	3	0	
do	25	Out Condition Logic	2A19	•	•		1	0	3	0	

## 6.12 LE-Parameter

Size	No.	Name	Adr. (hex)	P	E	ro	Res.	Lower Limit	Upper Limit	Default Value	Unit
LE	0	Frequency Level 1	2B00	•			0,0125	0	409,58	0	Hz
LE	1	Frequency Level 2	2B01	•			0,0125	0	409,58	4	Hz
LE	8	Load Level 1	2B08	•			1	0	200	50	%
LE	9	Load Level 2	2B09	•			1	0	200	100	%
LE	16	Active Current Level 1	2B10	•			0,1	0	370	0	A
LE	17	Active Current Level 2	2B11	•			0,1	0	370	0	A
LE	32	OL-Warning Level	2B20	•			1	0	100	80	%
LE	36	Frequency Hysteresis	2B24				0,0125	0	20	0,5	Hz

### 6.13 In-Parameter

Size	No.	Name	Adr. (hex)	P	E	ro	Res.	Lower Limit	Upper Limit	Default Value	Unit
In	0	Inverter Type	2C00			•	table				
In	1	Rated Inverter Current	2C01			•	0,1	0	370,0		A
In	2	Max. Output Frequency	2C02			•	0,125	0	409,5875	409,5875	Hz
In	3	Max. Carrier Frequency	2C03			•	1	0	16	4	kHz
In	4	Software - Version	2C04			•	0,1			b100	
In	5	Software Date	2C05			•	0,1				
In	6	Configfile-No.	2C06			•	1	0	255	46	
In	7	Serial No. (Date)	2C07			•	1	0	65535	0	
In	8	Serial No. (Counter)	2C08			•	1	0	65535	0	
In	9	Serial No. (AB-No. high)	2C09			•	1	0	65535	0	
In	10	Serial No. (AB-No. low)	2C0A			•	1	0	65535	0	
In	11	Customer Number (high)	2C0B			•	1	0	65535	0	
In	12	Customer Number (low)	2C0C			•	1	0	65535	0	
In	13	QS-Number	2C0D			•	1	0	255	0	
In	40	Last Error	2C28			•	1	0	63	0	
In	41	Error Counter OC	2C29			•	1	0	255	0	
In	42	Error Counter OL	2C2A			•	1	0	255	0	
In	43	Error Counter OP	2C2B			•	1	0	255	0	
In	44	Error Counter OH	2C2C			•	1	0	255	0	

## 7 Annex for Software Version 1.32

This Annex is applicable for the software ES.F4.000-B332.

Configuration file No.: 71/72 ( as of COMBIVIS 3.7 )

### 7.1 Differences to the Standard-Software

The following innovations are integrated in this software:

- Motorpoti function
- Fast-Scan  
Operating mode with shorter scan times
- Positioning function

<b>New parameter:</b>	ru.34	Display Motorpoti value
	oP.26	Motorpoti function
	oP.27	Motorpoti min. value
	oP.28	Motorpoti max. value
	oP.29	Motorpoti time
	ud.12	Fast-Scan-operating mode
	EP.05	Positioning
	EP.06	Correction factor
	EP.07	Shifting factor
	EP.08	Set change time lock
<b>Extended parameter:</b>	oP.0	Frequency reference source
	di.3/4	Input function

#### 7.1.1 Motorpoti function

The motorpoti function enables a setpoint input via two digital inputs. This function corresponds with the principle of a mechanic motorpoti.

*Display Motorpoti value (ru.34)*

The display shows the actual status motorpoti of the setpoint value. By writing in ru.34 the setpoint value between -100% and +100% can be preset with a resolution of 0,01%.

*Frequency reference source (oP.0)*

The values 15, 16, 17 are new in oP.0. Unused function numbers have the function like 0.  
The setpoint value preset via motorpoti for the values 15, 16, 17.

Value	Function
15	Direction of rotation: digital (oP.3)
16	Direction of rotation: terminal strip
17	Direction of rotation: motorpoti value

The rate of change and the motorpoti function can be adjusted with oP.26. The motorpoti function is not set programmable. The adjusted value is the sum of the decimal values.

*Motorpoti funktion  
oP.26*

3	2	1	0	Bit-No.
8	4	2	1	Decimal value (adjust the sum in oP.26)
x	x	x	0	Motorpoti is programmable in parameter sets; a change of setpoint is effective in active parameter set
x	x	x	1	Motorpoti not programmable in parameter sets; a change of setpoint is effective in all parameter sets
x	x	0	x	last Motorpoti value is active after power on
x	x	1	x	Reset of Motorpoti to 0% after power on
				times for the rate of change of the setpoint values
0	0	x	x	16 sec
0	1	x	x	33 sec
1	0	x	x	66 sec
1	1	x	x	Time adjusted with oP.29

oP.27 shows the lower limit of the motorpoti function. The motorpoti min. value is not set programmable. Data in %.

*Motorpoti min. value  
oP.27*

oP.28 shows the upper limit of the motorpoti function. The motorpoti max. value is not set programmable. Data in %.

*Motorpoti max. value  
oP.28*

oP.29 shows the time between lower limit and upper limit (oP.27 - oP.28). The motorpoti time is not set programmable. Data in seconds. Adjustable-setting range 0...300s.

*Motorpoti time oP.29*

New values:

*Input function  
di.3 / di.4*

Value	Function
7	increases the value of the motorpoti setpoint value
8	decreases the value of the motorpoti setpoint value
10	sets the motorpoti setpoint value at 0%

Storing of the changed setpoint values in EEPROM (if oP.26, Bit 1 = 0 no Reset after "Power on") occurs approx. 10 seconds after the last change of the setpoint values.

Adjustment of the motorpoti function:

1. Program one of the free programmable inputs to "increase motorpoti value" (7).
2. Program another one of the free programmable inputs to "decrease motorpoti value" (8).
3. Set setpoint value source at motorpoti (15-17).

Only by activation of the inputs the setpoint value can be increased/decreased. A setpoint value decrease always has a higher priority, meaning a simultaneous activation of incrementing an de-incrementing input the setpoint value is reduced.

Like the analog setpoint value setting the setpoint value is adjusted in the range Fmin (oP.4) und Fmax (oP.5). With oP.26 and oP.29 the speed of the range can be set. The following speeds are possible:

Bit 3	Bit 2	Significance
0	0	16 sec. 0 - 100%
0	1	33 sec. 0 - 100%
1	0	66 sec. 0 - 100%
1	1	op.29 time is active

Further oP.26 specifies if the motorpoti function is set dependent (independent motorpoti for every parameter set) and if the motorpoti value(s) are reset after "Power On Reset".

Bit-Nr.	Decimal value	Significance
0	1	Motorpoti not programmable in parameter sets
1	2	Reset Motorpoti after Power on
2	4	Rate of change
3	8	Rate of change

## 7.1.2 Fast-Scan

*Fast-Scan (ud.12)*

Fast-Scan Operating mode:

The scan grid of the digital inputs is 1,5 ms (e.g. standard operating mode: 4 ms)

### Restrictions:

1. The switching rate in the Fast-Scan-Mode is fixed adjusted at 4 kHz.
2. Only units C/D housing size can operate in the Fast-Scan-Mode.
3. In the Fast-Scan-Mode autoboot and slip compensation do not have an effect. The active current is not displayed.

In the Fast-Scan Mode there is no display and utilization of active and apparent current of units in a E-housing. Because of that, different safety functions (OL-function, current control etc.) could be omitted the units with output sensor technology don't operate in the Fast-Scan-Mode. If ud.12 = 1 (Fast scan) is switched on, this adjustment does not have an effect. The inverter runs in the standard operating mode.

A change of ud.12 will only become effective after the units are switched on again. Loading of the default-values (FR.0/FR.1) doesn't change the adjustment of ud.12.



### 7.1.3 Positioning Function

This positioning software enables a start of a position with only one signal also when there are different speeds (fast/slow speed switching is omitted). A fast positioning function and an easy triggering are the advantages of this software.

The positioning function is triggered via an external signal by removing the direction of rotation. Removing of the rotation direction is realized by changing into a set without programmed direction of rotation. To avoid electromagnetic disturbances, parameter oP.0 must be set to a value with digital rotation presetting and a direction of rotation is not preset.

Correct positioning is only possible if the max. frequency of the positioning set is not exceeded when triggering the positioning (e.g. by set change).

With this parameter the positioning is switched on/off.

*Positioning  
EP.05*

- oFF Positioning deactivated
- on Positioning by additional constant running time

If the positioning is switched on, ud.12 must be changed to Fast-Scan-Mode and initialized with "Power off".

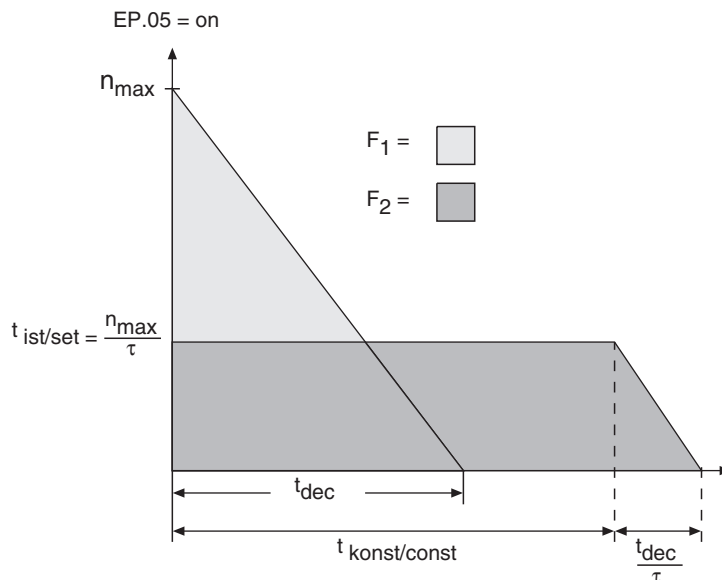

Correcting factor (EP.07)  
Shifting factor (EP.06)

These parameters allow an error correction during the positioning process in reference to various speeds. With EP.07 errors caused by slip (load characteristic), release delay and inaccuracies are compensated. Parameter EP.06 makes it possible to shift the holding position (replaces the shifting of an initiator). The values are not standardized and must be determined empirically.

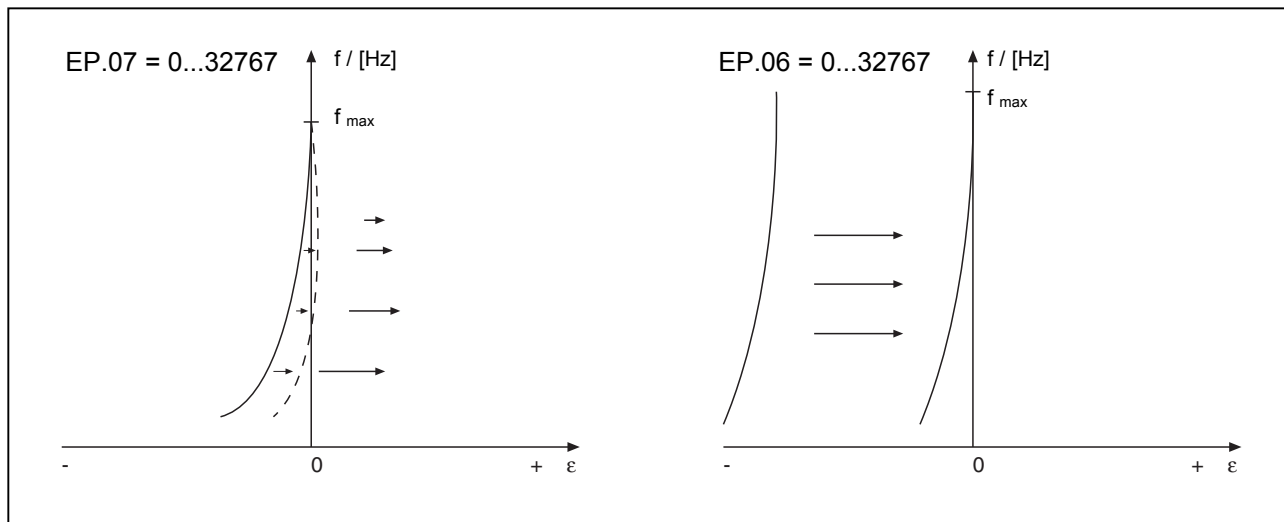

Set change time lock (EP.08)

After triggering of the positioning a change can be delayed with this parameter. This function enables the adjustment of a defined holding time in the reached position.

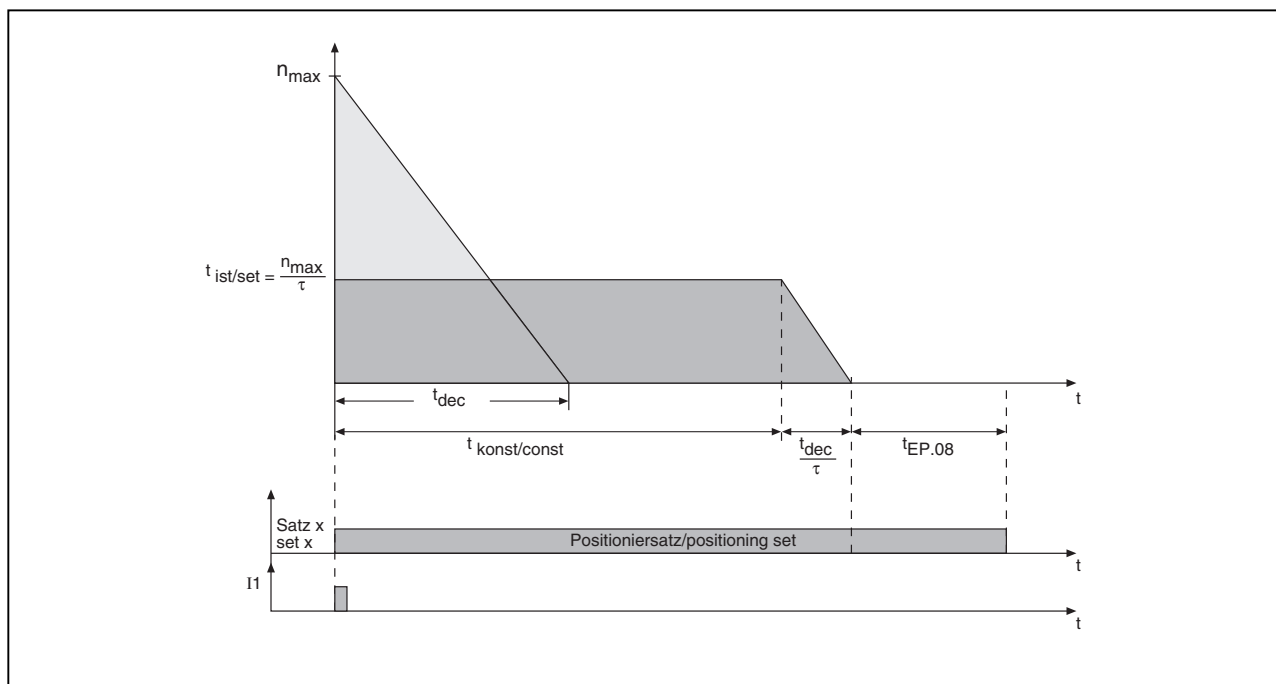

### 7.1.3.1 Positioning example

1. A signal is available for triggering of the positioning and will be active until the position is reached.

EP.05 = 1  
EP.06 as required  
EP.07 as required  
oP.00 = 1  
ud.12 = 1

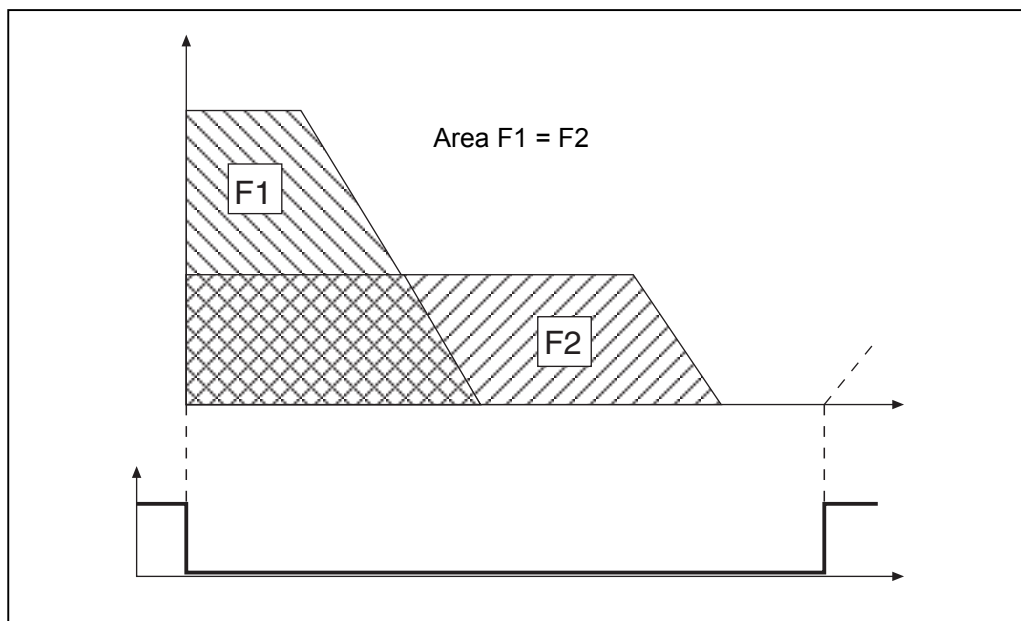

- For triggering of the positioning process only one impuls of the proximity switch is available. Other positions can be triggered with a reset of the shifting factor EP.06 in set 2 and 3.

## Set 0

FR.02 = 3  
di.03 = 1  
di.04 = 2  
di.18 = 48  
di.19 = 48  
oP.00 = 0  
oP.03 = 1  
ud.12 = 1

## Set 1

EP.05 = 1  
EP.06 as required  
EP.07 as required  
oP.00 = 0  
oP.03 = 0

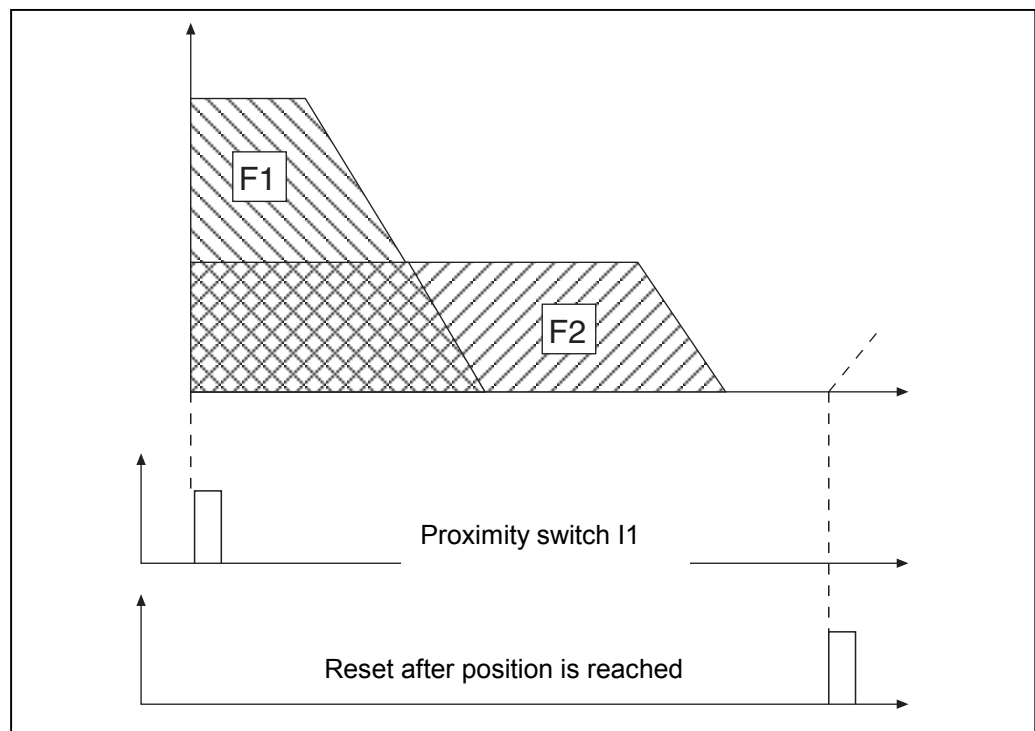

### 3. Automatic positioning

Set 0

EP.08 = Time the drive shall stay at the reached position.

FR.2 = 3

di.03 = 1

ud.12 = 1

Set 1

EP.05 = 1

EP.06 = as required

EP.07 = as required

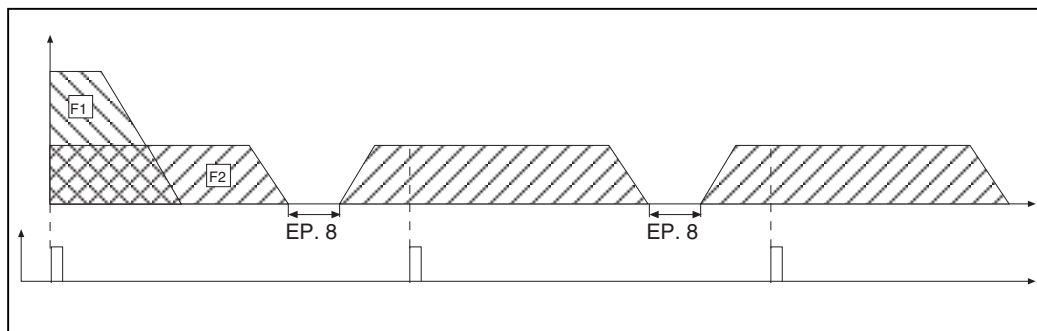







**Karl E. Brinkmann GmbH**  
Försterweg 36 - 38 • D - 32683 Barntrop  
Telefon 0 52 63 / 4 01 - 0 • Telefax 4 01 - 116  
Internet: [www.keb.de](http://www.keb.de) • E-mail: [info@keb.de](mailto:info@keb.de)